

VINYL SIDING
AND SOFFIT



Product Guide
2024



The largest manufacturer of exterior building products in North America

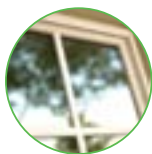

#1

Windows



#1

Vinyl Siding & Accessories



#1

Metal Roofing & Wall Systems



#1

Turnkey Stone
Installation Solutions

TABLE OF CONTENTS

Vinyl Siding Accessories Physical Properties	5-7
Series 5000	
Double 6"	8
Single 7"	8
Series 4400 II	
Standard Lap	10
Dutch Lap	10
Series 4400 Beaded	
Single 6 1/2"	10
Series 4200	
Standard Lap	11
Dutch Lap	11
Series 4010	
Dutch Lap	12
Series 3800	
Standard Lap	13
Dutch Lap	13
Series 4800	14
Series 9000	14
Double 5" Soffit	15
Series 1900	16
Beaded Soffit	17
Economy Triple 4" Soffit	18
Economy Double 5" Soffit	18
Beaded Soffit Installation Components	19
Soffit Installation Components	19

TABLE OF CONTENTS

Accent Panels & Installation Components

Series 1000	20
Shingle Siding	20
Round Cut Siding	20
Hand-Split Siding	20
Triple 5" Shingle	21

Installation Components 22

Ply Gem Shutters & Accents

Mounting Blocks & Utility Vents	31
Gable Vents	43
Shutters	47
Window Mantels	55
Color Matrix	59

Parkside® Skirting 60

Parkside® Skirting Accessories 61

Application Tools 62

Metal Accessories

Starter Strips	63
----------------------	----

TrueWall Vinyl Siding and Soffit products meet or exceed the following industry Standards and/or Building Code Approvals.

Standards and Codes	Report #
ASTM	C1363
ASTM	C272
ASTM	D2843 (U.B.C. #52-2)
ASTM	D3679
ASTM	D4226
ASTM	D4477
ASTM	D635
ASTM	E84
ASTM	E96
ICC Evaluation Service	NER-638
Metro Dade	08-0429.11
State of Florida	5538-R1
State of Florida	11191
State of Florida	5544
State of Florida	12141
Texas State Board of Insurance Ruling	EC-27

Compound Cell Classification: Polyvinyl Chloride (PVC) compound is defined as 13344-B in conformance to ASTM D 1784 (1/8 inch Izod specimen).

Weathering: Environmental exposure testing conducted in three environments; dry, hot climate (Arizona), hot, humid climate (Florida) and northern temperate climate per ASTM D 3679.

Color Monitoring: Lot-to-lot color monitoring conducted by Spectrophotometer per Standard Test Procedure CQA332Q3.

Lock: Precision formed using post formed technique.

Product specifications are accurate as of the printing date of this specification sheet.

VSI Fire Statement: Rigid vinyl siding is made from organic materials and will melt or burn when exposed to a significant source of flame or heat. Building owners, occupants and outside maintenance personnel should always take normal precautions to keep sources of fire, such as barbecues and combustible materials, such as dry leaves, mulch and trash, away from vinyl siding.

For a complete listing of certified products and information about the fire properties of vinyl siding, contact the Vinyl Siding Institute, 1201 15th St. NW, Suite 220, Washington, D.C., 20005 or visit the VSI website at vinylsiding.org for a current listing of certified products and colors.

Extruded Polyvinyl Chloride (PVC) consisting exclusively of PVC compound with the following typical properties:

Physical Properties	TrueWall Vinyl Siding & Soffit	ASTM Standard
Izod impact at 32°F, (ft.•lbF/in.)	1.9	0.65 min
Izod impact at 74°F, (ft.•lbF/in.)	3.3	2.4 min
Tensile strength, (psi)	6,326	5,800
Tensile modulus, (psi)	364,500	319,000 min
Heat deflection Temp., (°F) @ 264 psi	167	158 min
Coefficient of linear thermal expansion	3.3x10 ⁻⁵	4.5x10 ⁻⁵ max
Shore D hardness	82	n/a
Chemical resistance properties	Excellent	n/a
Flame spread index	20.0	25.0
Smoke density developed	275	n/a

Premium Color Panels Only

Physical Properties	TrueWall Vinyl Siding & Soffit	ASTM Standard
Tensile strength, (psi)	6,090	5,800
Heat deflection Temp., (°F) @ 264 psi	167	158 min
Modules of elasticity (PSI)	363,795	310,000 min
Izod impact at 32°F, (ft.•lbF/in.)	3.7	0.65 min
Izod impact at 74°F, (ft.•lbF/in.)	3.7	2.4 min
Shore D hardness	n/a	
Coefficient of linear thermal expansion	3.34x10 ⁻⁵	4.5x10 ⁻⁵ max
Chemical resistance properties	Excellent	n/a
Flame spread index		25.0
Smoke density developed		n/a

Injection Molded Painted Polypropylene

Physical Properties	TrueWall Vinyl Siding & Soffit	ASTM Standard
Panel color-thru	Yes	
Panel coating	None, Paint (variegated colors)	
Caliper of face	.101	
Caliper of nail hem between slots	.127	
Gloss	10	
Manufacturing Injection Physicals	Molded Polypropylene	
Wind load test (-100PSF)	195 m.p.h.	D5206-096
Impact test (ft.-lbs./in.)	1.0	D 250
Tensile strength (PSI)	2,900	D 638
Modules of elasticity (PSI)	340,000	
Deflection Temp. under flexural load (°F)	202	D648
Linear thermal expansion	1/16" per 30°F	D698
Flame spread index	95	E 84-84

Technical Specifications

Physical Properties	Design Pressure (DP)	Reference 30' Building Zone B Wind Velocity
Series 5000	68.9 PSF	180 MPH
Series 4400 II	89.4 PSF	190 MPH
Series 4200	56 PSF	160 MPH
Series 4400 Beaded	51 PSF	155 MPH
Series 4010	56 PSF	160 MPH
Series 3800	56 PSF	160 MPH
Series 1000 Shingle	73.3 PSF	180 MPH
Series 1000 Hand-Split	82.2 PSF	185 MPH
Series 1000 Round Cut	48.9 PSF	140 MPH

Compliance

TrueWall vinyl siding is listed in the National Evaluation Report-460. N.E.R.-460 and is recognized by SBCCI (Southern Builders Code Congress International), ICBO (International Conference of Building Officials) and BOCA (Building Officials and Code Administrators International).

TrueWall Vinyl Siding and Soffit is in conformance with ASTM D 3679, "Standard Specification for Rigid Polyvinyl Chloride (PVC) Siding."

SERIES 5000

DESCRIPTION & PACKAGING

COLOR AVAILABILITY

108

Double 6" Traditional

- 12' 6" Panel
- 62 Lbs./Ctn.
- 8 Pc./Ctn.
- 1 Sq./Ctn.
- 1-1/8" overall thickness
- Thickness: .044



Standard Colors

White
Almond
Cream
Gray
Mist
Pearl
Tan

Dark Colors*

Clay
Flint

Thistle

Premium Dark Colors*

Briarwood
Pewter
Sagebrook
Wedgewood

112

Single 7"

- 12' 3" Panel
- 68 Lbs./Ctn.
- 14 Pc./Ctn.
- 1 Sq./Ctn.
- 1-1/8" overall thickness



Standard Colors

White
Almond
Cream
Gray
Mist
Pearl
Tan

Dark Colors*

Clay
Flint

Thistle

Premium Dark Colors*

Briarwood
Pewter
Sagebrook
Wedgewood

300

Window & Door Surround

- Length: 12' 6"
- 39.48 Lbs./Ctn.
- 10 Pc./Ctn.

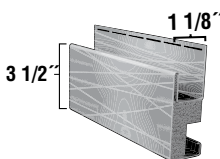

Standard Colors

White
Almond
Cream
Gray
Mist
Pearl
Tan

Dark Colors*

Clay
Flint
Thistle

352

Outside Corner Post

- Length: 12' 0"
- 55.88 Lbs./Ctn.
- 10 Pc./Ctn.

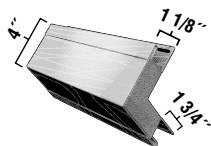

Standard Colors

White
Almond
Cream
Gray
Mist
Pearl
Tan

Dark Colors*

Clay
Flint

Thistle

Premium Dark Colors*

Briarwood
Pewter
Sagebrook
Wedgewood

359

Inside Corner Post

- Length: 12' 0"
- 29.54 Lbs./Ctn.
- 10 Pc./Ctn.

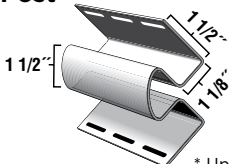

[Installing vinyl siding panels](#)

[Replacing panels and outside corners](#)



* Upcharge applies.

DESCRIPTION & PACKAGING

COLOR AVAILABILITY

40023

1-1/4" J-Channel

- Length: 12' 6"
- 12' 6" Panel
- 63.10 Lbs./Ctn.
- 40 Pc./Ctn.

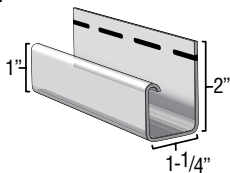

Standard Colors

White
Almond
Cream
Gray
Mist
Pearl
Tan

Dark Colors*

Clay
Flint

Thistle

Premium Dark Colors*

Briarwood
Pewter
Sagebrook
Wedgewood

505

Starter Strip

- Length: 12' 6"
- 42 Lbs./Ctn.
- 24 Pc./Ctn.



N/A

409

Extended Crown Backplate

- Length: 12' 6"
- 60.90 Lbs./Ctn.
- 24 Pc./Ctn.

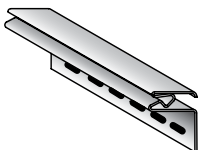

Standard Color

White

369

3-1/2" Transition Mold

- Length: 12' 6"
- 41.08 Lbs./Ctn.
- 10 Pc./Ctn.

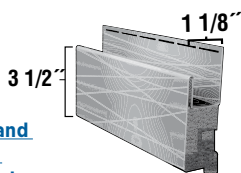

Standard Colors

White
Almond
Cream
Gray
Pearl
Mist

Tan

Dark Colors*

Clay
Flint
Thistle



[Flashing and installing corner posts](#)



[Corner post options](#)

[Foam-backed siding options](#)



* Upcharge applies.

SERIES 4400 II

DESCRIPTION & PACKAGING

284-04

Double 4" Standard Lap Low-Gloss Finish

- Length: 12' 6"
- Thickness: .044
- 114 Lbs./Ctn.
- 24 Pc./Ctn. / 2 squares

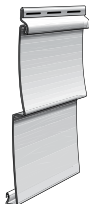

285-04

Double 4.5" Dutch Lap Low-Gloss Finish

- Length: 12' 1"
- Thickness: .044
- 111 Lbs./Ctn.
- 22 Pc./Ctn. / 2 squares



COLOR AVAILABILITY

Standard Colors

White
Almond
Cream
Gray
Pearl
Tan

Dark Colors*

Clay
Flint
Hazelnut
Thistle

Premium Colors*

Bayou
Briarwood
Brunswick
Dublin
Hampton
Red
Iron

Palm
Pewter
Sagebrook
Shadow
Teak
Wedgewood
Cedar Colors*
Coastal Blue
Hearthstone
Brown
Northern
Oak
Redwood

SERIES 4400 BEADED

200

6-1/2" Beaded Panel Smooth, Brushed Finish

Recommended for installation with
1WAP10 Aluminum Starter Strip.
See page 58

- Length: 12' 4"
- Thickness: .044
- 60.09 Lbs./Ctn.
- 15 Pc./Ctn.
- 1 square

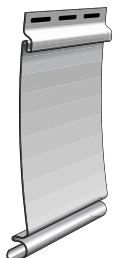

Standard Colors

White
Almond
Blue
Cream
Gray
Mist
Olive
Pearl
Tan

Dark Colors*

Clay
Flint
Thistle



[Vinyl siding
profile options](#)

[Install
horizontal
beaded
siding](#)



[Horizontal
siding - last
course in eave &
gable](#)



* Upcharge applies.

DESCRIPTION & PACKAGING

COLOR AVAILABILITY

105-04

Double 4" Standard Lap Woodgrain Finish

- Length: 12' 6"
- Thickness: .042
- 94.67 Lbs./Ctn.
- 24 Pc./Ctn. / 2 squares



Standard Colors

White
Almond
Blue
Cream
Gray
Mist
Olive
Pearl
Tan

Clay
Cypress
Flint
Hazelnut
Thistle

Premium Colors*

Briarwood
Pewter
Sagebrook
Wedgewood

Dark Colors*

116-04

Double 5" Standard Lap Woodgrain Finish

- Length: 12' 0"
- Thickness: .042
- 89.61 Lbs./Ctn.
- 20 Pc./Ctn. / 2 squares



109-04

Double 4" Dutch Lap Woodgrain Finish

- Length: 12' 6"
- Thickness: .042
- 94.96 Lbs./Ctn.
- 24 Pc./Ctn. / 2 squares



119-04

Double 5" Dutch Lap Woodgrain Finish

- Length: 12' 0"
- Thickness: .042
- 89.67 Lbs./Ctn.
- 20 Pc./Ctn. / 2 squares



* Upcharge applies.

SERIES 4010

DESCRIPTION & PACKAGING

COLOR AVAILABILITY

10002-04

Double 5" Dutch Lap Woodgrain Finish

- Length: 12' 0"
- Thickness: .040
- 84.50 Lbs./Ctn.
- 20 Pcs./Ctn.
- 2 Sqs./Ctn.



Standard Colors

White
Almond
Blue
Cream
Gray
Mist
Olive
Pearl
Tan

Dark Colors*

Clay
Cypress
Flint
Thistle

10003-04

Double 4.5" Dutch Lap Woodgrain Finish

- Length: 12' 1"
- Thickness: .040
- 87 Lbs./Ctn.
- 22 Pcs./Ctn.
- 2 Sqs./Ctn.



10005-04

Double 5" Standard Lap Woodgrain Finish

- Length: 12' 0"
- Thickness: .040
- 84.25 Lbs./Ctn.
- 20 Pcs./Ctn.
- 2 Sqs./Ctn.



* Upcharge applies.

SERIES 3800

DESCRIPTION & PACKAGING

COLOR AVAILABILITY

106-04

Double 4" Dutch Lap Woodgrain Finish

- Length: 12' 6"
- Thickness: .038
- 83.34 Lbs./Ctn.
- 24 Pcs./Ctn.
- 2 Sqs./Ctn.



Standard Colors

White
Almond
Blue
Cream
Gray
Mist
Olive
Pearl
Tan

Dark Colors*

Clay
Cypress
Flint

115-04

Double 5" Dutch Lap Woodgrain Finish

- Length: 12' 0"
- Thickness: .038
- 76.30 Lbs./Ctn.
- 20 Pcs./Ctn.
- 2 Sqs./Ctn.



110-04

Double 4.5" Dutch Lap Woodgrain Finish

- Length: 12' 1"
- Thickness: .038
- 80.45 Lbs./Ctn.
- 22 Pcs./Ctn.
- 2 Sqs./Ctn.



* Upcharge applies.

DESCRIPTION & PACKAGING

COLOR AVAILABILITY

199

Single Vertical 7" Board & Batten Woodgrain Finish

- Length: 10' 0"
- Thickness: .048
- 53.90 Lbs./Ctn.
- 17 Pc./Ctn.
- 1 Sq./Ctn.



Standard Colors

White
Almond
Beige
Blue
Cream
Gray
Mist
Olive
Pearl
Tan

Dark Colors*

Clay
Flint
Hazelnut

Thistle

Premium Colors*

Bayou
Briarwood
Brunswick
Dublin
Hampton Red
Palm
Pewter
Sagebrook
Shadow
Teak
Wedgewood

SERIES 9000

133

Triple 3-1/3" Solid Vertical/Soffit Pebble Finish

- Length: 12' 0"
- Thickness: .044
- 119 Lbs./Ctn.
- 20 Pc./Ctn.
- 2 Sqs./Ctn.

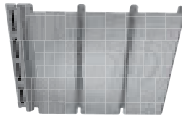

**Musket Brown approved for soffit use only.

Standard Colors

White
Almond

Dark Colors*

Clay
Musket Brown**

Premium Colors*

Briarwood
Shadow
Teak

134

Triple 3-1/3" Vented Soffit Pebble Finish

- Length: 12' 0"
- Thickness: .044
- 115 Lbs./Ctn.
- 20 Pc./Ctn.
- 2 Sqs./Ctn.
- Net Free Air Space: 9.19 Sq. In./Sq. Ft.

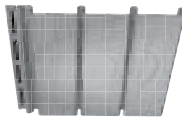

Use 5/8" installation accessories
Approved for soffit use only.

[Installing vertical siding](#)



[Vertical siding options](#)



[Soffit options](#)



* Upcharge applies.

DESCRIPTION & PACKAGING

COLOR AVAILABILITY

140

Series 9300 Vertical/Soffit Woodgrain Finish

- Length: 12' 0"
- Thickness: .044
- 94.50 Lbs./Ctn.
- 20 Pc./Ctn.
- 2 Sqs./Ctn.



Standard Colors

White
Almond
Blue
Mist
Pearl
Tan

Dark Colors*

Clay
Thistle

141

Series 9300 Perforated Soffit Woodgrain Finish

- Length: 12' 0"
- Thickness: .044
- 89.14 Lbs./Ctn.
- 20 Pc./Ctn.
- 2 Sqs./Ctn.
- Net Free Air Space: 6.20 Sq. In./Sq. Ft.

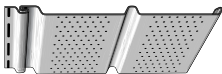

Approved for soffit use only.

144

Series 9200 Soffit Woodgrain Finish

- Length: 12' 0"
- Thickness: .040
- 86.64 Lbs./Ctn.
- 20 Pc./Ctn.
- 2 Sqs./Ctn.



Approved for soffit use only.

Use 1/2" installation accessories

Standard Colors

White
Almond
Beige
Cream
Gray
Mist
Olive
Pearl
Tan

Dark Colors*

Clay
Flint

145

Series 9200 Perforated Soffit Woodgrain Finish

- Length: 12' 0"
- Thickness: .040
- 81.78 Lbs./Ctn.
- 20 Pc./Ctn.
- 2 Sqs./Ctn.
- Net Free Air Space: 6.20 Sq. In./Sq. Ft.



Approved for soffit use only.

Use 1/2" installation accessories

[Installing vinyl soffits](#)



* Upcharge applies.

DESCRIPTION & PACKAGING

COLOR AVAILABILITY

230

Series 9100 Solid Soffit Pebble Finish

- Length: 12' 0"
- Thickness: .038
- 80.62 Lbs./Ctn.
- 16 Pc./Ctn.
- 1.92 Sqs./Ctn.



Approved for soffit use only.

Standard Colors

White
Almond
Beige
Blue
Cream
Gray
Mist
Pearl
Tan

Dark Colors*

Black
Clay
Flint
Musket Brown

231

Series 9100 Center Vent Soffit Pebble Finish

- Length: 12' 0"
- Thickness: .038
- 79.90 Lbs./Ctn
- 16 Pc./Ctn.
- 1.92 Sqs./Ctn.
- Net Free Air Space: 1.956 Sq. In./Sq. Ft.

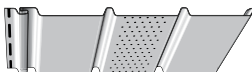

Approved for soffit use only.

Standard Colors

White
Almond
Tan

Dark Colors*

Black
Clay
Musket Brown

232

Series 9100 Full Vent Soffit Pebble Finish

- Length: 12' 0"
- Thickness: .038
- 78.48 Lbs./Ctn
- 16 Pc./Ctn.
- 1.92 Sqs./Ctn.
- Net Free Air Space: 5.867 Sq. In./Sq. Ft.

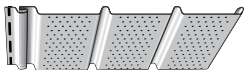

Use 1/2" installation accessories
Approved for soffit use only.

Standard Colors

White
Almond
Beige
Blue
Cream
Gray
Mist
Pearl
Tan

Dark Colors*

Black
Clay
Flint
Musket Brown

* Upcharge applies.

SOFFIT

DESCRIPTION & PACKAGING

COLOR AVAILABILITY

157

Beaded, 7" Exposure Solid Soffit w/Pebble Finish

- Length: 12' 0"
- Thickness: .040
- 114.61 Lbs./Ctn.
- 28 Pc./Ctn.
- 2 Sqs./Ctn.



Standard Colors
White
Almond
Blue
Pearl
Tan

Dark Color*
Clay

158

Beaded, 7" Exposure Hidden-Vent Soffit w/Pebble Finish

- Length: 12' 0"
- Thickness: .040
- 113.56 Lbs./Ctn.
- 28 Pc./Ctn.
- 2 Sqs./Ctn.
- Net Free Air Space: 2.66 Sq. In./Sq. Ft.



Use 3/8" installation accessories
Approved for soffit use only.

2309216

Economy Triple 4" Solid Soffit

- Length: 12' 0"
- Thickness: .038
- 80.62 Lbs./Ctn.
- 16 Pc./Ctn.
- 1.92 Sqs./Ctn.



Approved for soffit use only.

Standard Color
White

2319216

Economy Triple 4" Center Vent Soffit

- Length: 12' 0"
- Thickness: .038
- 79.90 Lbs./Ctn
- 16 Pc./Ctn.
- 1.92 Sqs./Ctn.
- Net Free Air Space: 1.956 Sq. In./Sq. Ft.

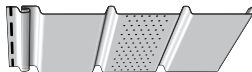

Approved for soffit use only.

* Upcharge applies.

DESCRIPTION & PACKAGING

COLOR AVAILABILITY

2329216

Economy Triple 4" Full Vent Soffit

- Length: 12' 0"
- Thickness: .038
- 78.48 Lbs./Ctn
- 16 Pc./Ctn.
- 1.92 Sqs./Ctn.
- Net Free Air Space: 5.867 Sq. In./Sq. Ft.

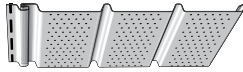

**Standard
Color**
White

Use 1/2" installation accessories
Approved for soffit use only.

1449216

Economy Double 5" Solid Soffit

- Length: 12' 0"
- Thickness: .038
- 94.50 Lbs./Ctn.
- 20 Pc./Ctn.
- 2 Sqs./Ctn.



Approved for soffit use only.

1459216

Economy Double 5" Full Vent Soffit

- Length: 12' 0"
- Thickness: .038
- 89.14 Lbs./Ctn.
- 20 Pc./Ctn.
- 2 Sqs./Ctn.
- Net Free Air Space: 6.20 Sq. In./Sq. Ft.



Approved for soffit use only.

[Installing porch
ceilings/beaded
soffit](#)



* Upcharge applies.

BEADED SOFFIT INSTALLATION COMPONENTS

DESCRIPTION & PACKAGING

COLOR AVAILABILITY

304

3/8" J-Channel Pebble Finish

- Length: 12' 6"
- 40.78 Lbs./Ctn.
- 40 Pc./Ctn.

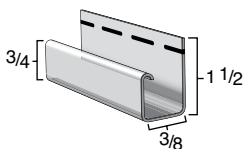

Standard Colors
White
Almond
Blue
Pearl
Tan

Dark Color
Clay

SOFFIT INSTALLATION COMPONENTS

339

1/2" F-Trim Pebble Finish

- Length: 12' 6"
- 44.33 Lbs./Ctn.
- 40 Pc./Ctn.
- 2 Sqs./Ctn.
- 500 Ft./Ctn.

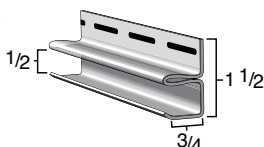

Standard Colors
White
Almond
Beige
Blue
Cream
Gray
Mist
Olive
Pearl
Tan

Dark Colors*
Black
Clay
Flint
Musket Brown*
Thistle

336

1/2" J-Channel Pebble Finish

- Length: 12' 6"
- 41.18 Lbs./Ctn.
- 40 Pc./Ctn.
- 500 Ft./Ctn.

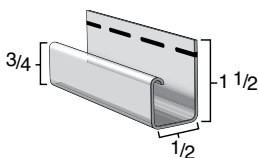

Standard Colors
White
Almond
Beige
Blue
Cream
Gray
Mist
Olive
Pearl
Tan

Dark Colors
Black
Clay
Flint
Musket Brown*
Thistle

* Upcharge applies.

SERIES 1000 & INSTALLATION COMPONENTS

DESCRIPTION & PACKAGING

COLOR AVAILABILITY

556-04

Shingle Siding[†]

- Length: 54-5/8"
- Nominal Thickness: .100
- 43 Lbs./Ctn.
- 10 Pc./Ctn.
- 1/2 Sq./Ctn.

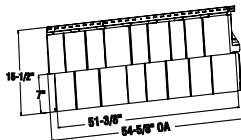

[†] Requires 7/8" pocket accessories.

Standard Colors

White
Almond
Bayou
Briarwood
Brunswick
Clay
Cream
Dublin
Flint
Gray
Hampton Red
Hazelnut
Iron
Olive
Palm
Pearl
Pewter
Sagebrook

Shadow
Tan
Teak
Thistle
Wedgewood
Shaded Colors*
Shaded Cedar
Shaded Gray

557

Shingle Outside Corner Post

- 3-1/2" Width
- Nominal Thickness: .100
- 15.7 Lbs./Ctn.
- 10 Pc./Ctn.
- 23.3 Ft. Exposure/Ctn.



559-04

Round Cut Siding[†]

- Length: 51-3/4"
- Nominal Thickness: .080
- 39 Lbs./Ctn.
- 12 Pc./Ctn.
- 1/2 Sq./Ctn.

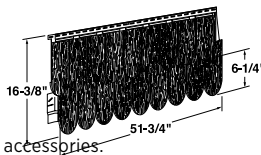

[†] Requires 7/8" pocket accessories.

Standard Colors

White
Almond
Clay
Cream
Flint
Gray
Pearl
Tan

560-04

Hand-Split Siding[†]

- Length: 58-1/8"
- Nominal Thickness: .100
- 41 Lbs./Ctn.
- 7 Pc./Ctn.
- 1/2 Sq./Ctn.

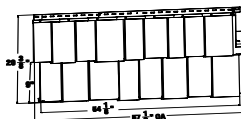

[†] Requires 7/8" pocket accessories.

Standard Colors

White
Almond
Bayou
Clay
Cream
Flint
Gray
Hampton Red
Pearl
Pewter

Sagebrook
Shadow
Tan
Thistle
Wedgewood
Shaded Colors*
Shaded Cedar
Shaded Gray

* Upcharge applies.

SERIES 1000 & INSTALLATION COMPONENTS

DESCRIPTION & PACKAGING

COLOR AVAILABILITY

558

Hand-Split Outside Corner Post

- 3-1/2" Width
- Nominal Thickness: .100
- 20 Lbs./Ctn.
- 10 Pc./Ctn.
- 30 Ft. Exposure/Ctn.

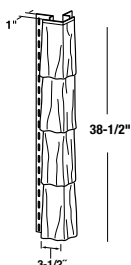

Standard Colors

White
Almond
Bayou
Clay
Cream
Flint
Gray
Hampton Red
Pearl
Pewter
Sagebrook

Shadow

Tan
Teak
Thistle
Wedgewood

Shaded Colors*

Shaded Cedar
Shaded Gray

570-04

Triple 5" Shingle

- 69-1/2" Width
- Nominal Thickness: .090
- 35 Lbs./Ctn.
- 18 Ctns. @ 7 Pc./Ctn.

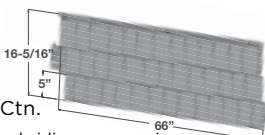

Note: 3/4" minimum vinyl siding accessories are required for installation.

Standard Colors

White
Almond
Briarwood
Clay
Cream
Flint
Gray
Hampton Red
Hazelnut
Olive
Palm
Pearl
Pewter
Sagebrook
Shadow
Tan
Teak
Thistle
Wedgewood

Colors*

Shaded Cedar
Shaded Gray

571

Triple 5" Shingle Outside Corner Post

- Length: 31"
- Nominal Thickness: .080
- 19.50 Lbs./Ctn.
- 10 Pc./Ctn.
- 31" l x 1" projection x 3-1/2" w

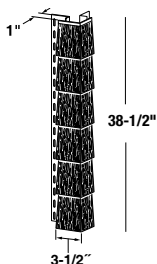

Shaded



[Cedar panels - last panel in eave & gable](#)

[Install cedar panels](#)



[How to replace a cedar panel](#)



* Upcharge applies.

INSTALLATION COMPONENTS

DESCRIPTION & PACKAGING

COLOR AVAILABILITY

377

6" x 3/4" Fluted Outside Corner Post Pebble Finish

(A special order requirement will apply)

- Length: 20' 0"
- 41.58 Lbs./Ctn.
- 4 Pc./Ctn. / 80 Ft./Ctn.

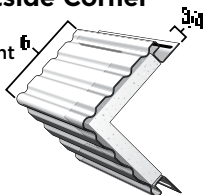

Standard Color
White

407

Traditional 5 1/2" Outside Corner Post Pebble Finish

(A special order requirement will apply)

- Length: 20' 0"
- 67 Lbs./Ctn.
- 4 Pc./Ctn. / 80 Ft./Ctn.

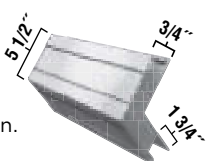

40020

4" x 3/4" Outside Corner Post New Woodgrain Finish

- Length: 10' 0"
- 50 Lbs./Ctn.
- 10 Pc./Ctn. / 100 Ft./Ctn.

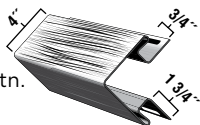

Standard Colors

White
Almond
Beige
Blue
Cream
Gray
Mist
Olive
Pearl
Tan

Dark Colors

Clay
Cypress
Flint
Hazelnut
Thistle

Premium Colors*

Bayou
Briarwood
Brownstone
Brunswick
Dublin
Hampton
Red
Iron
Palm
Pewter
Sagebrook
Shadow
Teak
Wedgewood

40041

4" x 3/4" Outside Corner Post New Woodgrain Finish

- Length: 10' 0"
- 25 Lbs./Ctn.
- 5 Pc./Ctn. / 50 Ft./Ctn.

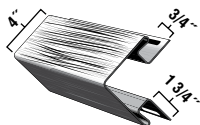

Cedar Colors

Costal Blue
Hearthstone
Brown
Nothern Oak
Redwood

* Upcharge applies.

INSTALLATION COMPONENTS

DESCRIPTION & PACKAGING

COLOR AVAILABILITY

40022

3" x 3/4" Outside Corner Post New Woodgrain Finish

- Length: 10' 0"
- 37 Lbs./Ctn.
- 10 Pc./Ctn. / 100 Ft./Ctn.

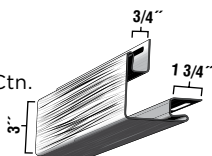

Standard Colors

White
Almond
Beige
Blue
Cream
Gray
Mist
Olive

Pearl
Tan

Dark Colors

Clay
Cypress
Flint
Hazelnut
Thistle

40034

3" x 3/4" Outside Corner Post New Woodgrain Finish

- Length: 10' 6"
- 39.44 Lbs./Ctn.
- 10 Pc./Ctn. / 105 Ft./Ctn.

Designed for IMH

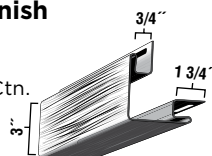

Standard Colors

White
Almond
Cream
Gray
Mist
Olive

Pearl
Tan

Dark Colors

Clay
Flint

40033

3" x 3/4" Outside Corner Post New Woodgrain Finish

- Length: 8' 6"
- 34 Lbs./Ctn.
- 10 Pc./Ctn. / 85 Ft./Ctn.

Designed for IMH

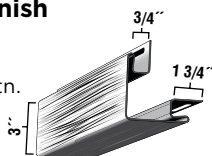

Standard Colors

White
Almond
Beige
Cream
Gray
Mist
Olive

Pearl
Tan

Dark Colors

Clay
Flint

40032

Snap-On Corner Post New Woodgrain Finish (Use with J-Channel)

- Length: 10' 0"
- 69.77 Lbs./Ctn.
- 24 Pc./Ctn. / 240 Ft./Ctn.

Designed for IMH

NOTE: Replacing #354

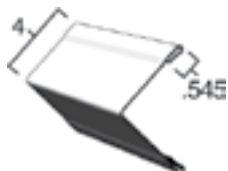

Standard Colors

White



[Flashing and installing corner posts](#)

* Upcharge applies.

INSTALLATION COMPONENTS

DESCRIPTION & PACKAGING

COLOR AVAILABILITY

376

2 1/4" x 5/8" Outside Corner Post Pebble Finish (Use with J-Channel)

- Length: 8' 6"
- 40 Lbs./Ctn.
- 16 Pc./Ctn. / 136 Ft./Ctn.

Designed for IMH

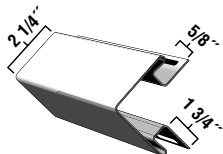

Standard Colors

White
Almond
Beige
Blue
Cream
Gray
Mist

Olive
Pearl
Tan

Dark Colors

Clay
Flint

362

Bay Window Corner Pebble Finish

- Length: 10' 0"
- 34.72 Lbs./Ctn.
- 10 Pc./Ctn. / 100 Ft./Ctn.

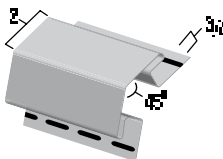

Standard Color

White

364

3/4" Inside Corner Post Pebble Finish

- Length: 10' 0"
- 24.43 Lbs./Ctn.
- 10 Pc./Ctn. / 100 Ft./Ctn.

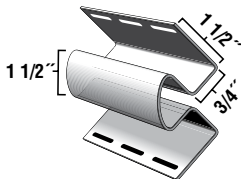

Standard Colors

White
Almond
Beige
Blue
Cream
Gray
Mist
Olive
Pearl
Tan

Dark Colors

Clay
Cypress
Flint
Hazelnut
Thistle

Premium Colors*

Bayou
Briarwood
Brunswick
Dublin
Hampton Red
Iron
Palm
Pewter
Sagebrook
Shadow
Teak
Wedgewood

40042

3/4" Inside Corner Post Pebble Finish

- Length: 10' 0"
- 14.66 Lbs./Ctn.
- 6 Pc./Ctn. / 60 Ft./Ctn.

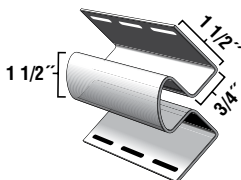

Cedar Colors*

Costal Blue
Hearthstone
Brown
Nothorn Oak
Redwood

* Upcharge applies.

INSTALLATION COMPONENTS

DESCRIPTION & PACKAGING

COLOR AVAILABILITY

391

5" Window and Door Surround Pebble Finish

- Length: 20' 0"
- 64.73 Lbs./Ctn.
- 10 Pc./Ctn. /
200 Ft./Ctn.

Use with 393 Starter Strips
(A special order requirement will apply)

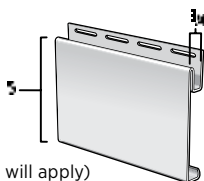

Standard Colors
White

390

3 3/4" Window and Door Surround Pebble Finish

- Length: 20' 0"
- 57.28 Lbs./Ctn.
- 10 Pc./Ctn. /
200 Ft./Ctn.

Use with 393 Starter Strips
(A special order requirement will apply)

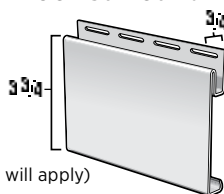

Standard Colors
White
Tan

395

3 3/4" Window and Door Surround Pebble Finish

- Length: 12' 6"
- 37.11 Lbs./Ctn.
- 10 Pc./Ctn. /
125 Ft./Ctn.

Use with 393 Starter Strips

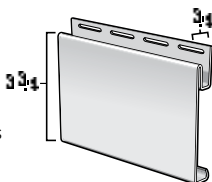

Standard Color
White

40029

Wide Flange J-Channel Pebble Finish

- Length: 12' 6"
- 55 Lbs./Ctn.
- 20 Pc./Ctn. /
250 Ft./Ctn.

NOTE: Replacing #316

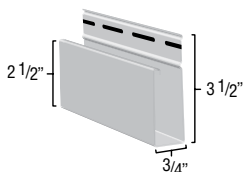

Standard Colors
White
Almond
Tan
Dark Colors
Clay

* Upcharge applies.

INSTALLATION COMPONENTS J-CHANNEL

DESCRIPTION & PACKAGING

COLOR AVAILABILITY

40024

7/8" J-Channel Pebble Finish

- Length: 12' 6"
- 44.18 Lbs./Ctn.
- 40 Pc./Ctn. / 500 Ft./Ctn.

NOTE: Replacing #307

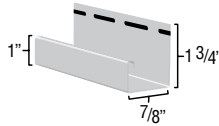

Standard Colors

White
Almond
Cream
Gray
Olive
Pearl
Tan

Dark Colors

Clay
Flint
Hazelnut
Thistle

Premium Colors*

Bayou
Briarwood
Brunswick
Dublin
Hampton Red
Iron
Pewter
Sagebrook
Shadow
Teak
Wedgewood

40026

5/8" Extended Face J-Channel Pebble Finish

- Length: 12' 6"
- 46 Lbs./Ctn.
- 40 Pc./Ctn. / 500 Ft./Ctn.

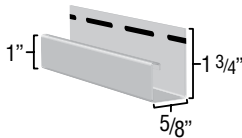

Standard Colors

White
Almond
Beige
Blue
Cream
Gray
Mist
Olive
Pearl
Tan

Dark Colors

Clay
Cypress
Flint
Hazelnut
Thistle

Premium Colors*

Bayou
Briarwood
Brunswick
Dublin
Hampton Red
Iron
Palm
Pewter
Sagebrook
Shadow
Teak
Wedgewood

40045

7/8" J-Channel Pebble Finish

- Length: 12' 6"
- 26 Lbs./Ctn.
- 20 Pc./Ctn. / 250 Ft./Ctn.

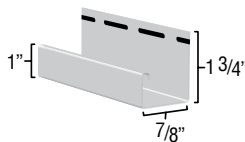

Cedar Colors*

Costal Blue
Hearthstone
Brown
Nothern Oak
Redwood

[J-Channel options](#)



[Starter strip](#)



[Designer accents](#)

* Upcharge applies.

INSTALLATION COMPONENTS

J-CHANNEL

DESCRIPTION & PACKAGING

COLOR AVAILABILITY

40043

5/8" Extended Face J-Channel Pebble Finish

- Length: 12' 6"
- 23 Lbs./Ctn.
- 20 Pc./Ctn. / 250 Ft./Ctn.

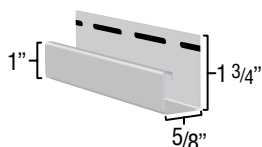

Cedar Colors*

Costal Blue
Hearthstone
Brown
Nothern Oak
Redwood

36585

5/8" J-Channel Pebble Finish

- Length: 12' 6"
- 44.29 Lbs./Ctn.
- 40 Pc./Ctn. / 500 Ft./Ctn.

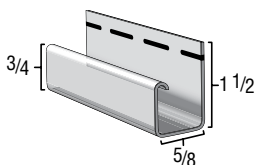

Standard Colors

White
Almond
Beige
Blue
Cream
Gray
Mist
Olive
Pearl
Tan

Thistle
Musket Brown*

Premium Colors*

Briarwood
Hampton Red
Pewter
Sagebrook
Wedgewood

Dark Colors

Clay
Cypress
Flint
Hazelnut

506

3/4" Flexible J-Channel Matte Finish

- Length: 12' 6"
- 66 Lbs./Ctn.
- 20 Pc./Ctn. / 250 Ft./Ctn.

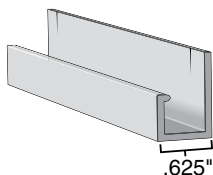

Standard Color

White

40046

3-1/2" Interlocking Foam Back Lineal

- Length: 12' 6"
- 65 Lbs./Ctn.

Note: Interlocks into vinyl windows with integrated siding receiver

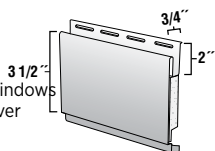

Standard Colors

White
Tan

Dark Color
Clay

* Upcharge applies.

INSTALLATION COMPONENTS

DESCRIPTION & PACKAGING

COLOR AVAILABILITY

40047

5" Interlocking Foam Back Lineal

- Length: 12' 6"
- 58 Lbs./Ctn.

Note: Interlocks into vinyl windows with integrated siding receiver

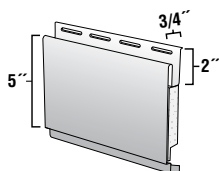

Standard Colors

White
Tan

Dark Color

Clay

40030

Window/Door Trim Pebble Finish

- Length: 12' 6"
- 82.88 Lbs./Ctn.
- 40 Pc./Ctn. / 500 Ft./Ctn.

Designed for IMH
NOTE: Replacing #347

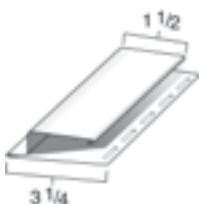

Standard Colors

White
Almond
Beige
Blue
Cream
Gray
Mist
Olive
Pearl
Tan

Dark Colors

Clay
Flint

40031

Window/Door Trim Pebble Finish

- Length: 8' 0"
- 57.21 Lbs./Ctn.
- 40 Pc./Ctn. / 320 Ft./Ctn.

Designed for IMH
NOTE: Replacing #347

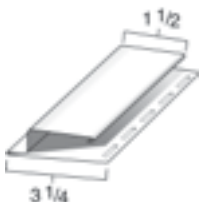

Standard Color

White

365

Wide Crown Mold Pebble Finish

- Length: 12' 6"
- 33.71 Lbs./Ctn.
- 24 Pc./Ctn. / 300 Ft./Ctn.

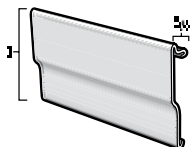

Standard Colors

White
Almond
Cream
Gray
Mist

Pearl
Tan

Dark Colors

Clay
Flint
Thistle



[Install lineals around new & remodeled windows](#)

[Install lineals as band boards and gables](#)



* Upcharge applies.

INSTALLATION COMPONENTS J-CHANNEL

DESCRIPTION & PACKAGING

COLOR AVAILABILITY

366

Universal Back Plate Pebble Finish

- Length: 12' 6"
- 34.79 Lbs./Ctn.
- 24 Pc./Ctn. /
300 Ft./Ctn.

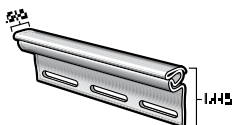

**Standard
Color**
White

367

Frieze Back Plate Pebble Finish

- Length: 12' 6"
- 44.51 Lbs./Ctn.
- 24 Pc./Ctn. /
300 Ft./Ctn.

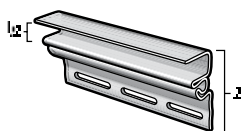

328

One Piece Wide Crown Mold Pebble Finish

- Length: 12' 6"
- 46.46 Lbs./Ctn.
- 24 Pc./Ctn. /
300 Ft./Ctn.

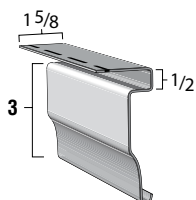

**Standard
Colors**
White
Dark Colors
Clay

327

Narrow Cove Mold Pebble Finish

- Length: 12' 6"
- 35.55 Lbs./Ctn.
- 24 Pc./Ctn. /
300 Ft./Ctn.

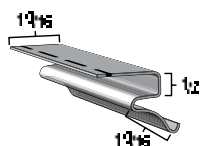

Designed for IMH
NOTE: Replacing #344

* Upcharge applies.

INSTALLATION COMPONENTS

DESCRIPTION & PACKAGING

COLOR AVAILABILITY

396

Dual Finish Trim Pebble Finish

- Length: 12' 6"
- 41.16 Lbs./Ctn.
- 24 Pc./Ctn. / 300 Ft./Ctn.



Standard Colors

White
Almond
Beige
Blue
Cream
Gray
Mist

Olive
Pearl
Tan

Dark Colors

Clay
Flint
Thistle

40028

Finish Trim Pebble Finish

- Length: 12' 6"
- 46 Lbs./Ctn.
- 40 Pc./Ctn. / 500 Ft./Ctn.

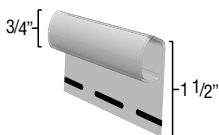

Standard Colors

White
Almond
Beige
Blue
Cream
Gray
Mist
Olive
Pearl
Tan

Premium Colors*

Bayou
Briarwood
Brunswick
Dublin
Hampton Red
Iron
Palm
Pewter
Sagebrook
Shadow
Teak
Wedgewood

Dark Colors

Clay
Flint
Hazelnut
Thistle

40044

Finish Trim Pebble Finish

- Length: 12' 6"
- 23 Lbs./Ctn.
- 20 Pc./Ctn. / 250 Ft./Ctn.

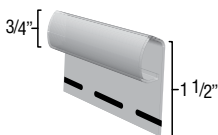

Cedar Colors*

Costal Blue
Hearthstone
Brown
Nothern Oak
Redwood

CDSS 00

Universal Aluminum Cedar Starter

- Length: 10' 0"
- 32 Lbs./Ctn.
- 50 Pc./Ctn.
- Nominal Thickness: .019

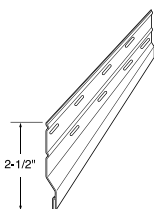

Mill Finish

* Upcharge applies.

PLY GEM SHUTTERS | ACCENTS MOUNTING BLOCKS & UTILITY VENTS

DESCRIPTION & PACKAGING

COLOR AVAILABILITY

UNIBLOCK

J-Block® Square Mounting Block

Mounting Surface:

- 5" x 6"

Trim Ring Dimensions:

- 7-1/4" x 8-1/8"

J-Channel I.D.:

- 1/2" adjusts to 1-1/4"

Knockouts:

- Round: 4" Diameter
- Rectangle: 2-3/8" x 3-3/4"

• 10 Pcs./Ctn.

• 6 Lbs./Ctn.

Uses: Light Fixtures, Electrical Receptacles, Water Faucets

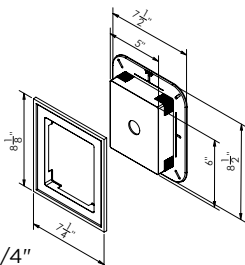

For color availability, refer to list on page 59.

UNIBLOCKSC

J-Block® Square Mounting Block Scroll 4" Knockout

Mounting Surface:

- 5" x 6"

Trim Ring Dimensions:

- 7-1/4" x 8-1/8"

J-Channel I.D.:

- 1/2" adjusts to 1-1/4"

Knockouts:

- Round: 4" Diameter
- Rectangle: 2-3/8" x 3-3/4"

• 10 Pcs./Ctn.

• 6 Lbs./Ctn.

Uses: Light Fixtures, Electrical Receptacles, Water Faucets

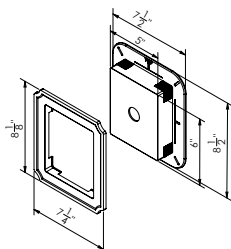

[Install mounting
blocks and fixture
vents](#)

PLY GEM SHUTTERS | ACCENTS MOUNTING BLOCKS & UTILITY VENTS

DESCRIPTION & PACKAGING

COLOR AVAILABILITY

MBLOCK

Mini J-Block[®] Mounting Block

Mounting Surface:

- 6" x 4-3/8"

Flange Dimensions:

- 6 7/8" x 5-1/4"

J-Channel I.D.:

- 3/4" adjusts to 1-1/4"

Knockouts:

- Round: 1-1/8" Diameter
- Rectangle: 2-3/8" x 3-3/4"

- 10 Pcs./Ctn.

- 3 Lbs./Ctn.

Uses: Doorbell, Electrical Outlet

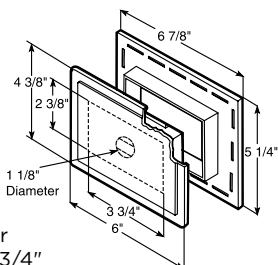

For color availability, refer to list on page 59.

MBLOCKR

Split Recessed J-Block[®] Mounting Block

Mounting Surface:

- 3-5/8" x 5-1/4"

Trim Ring Dimensions:

- 5-5/8" x 7-3/8"

J-Channel I.D.:

- 1/2" adjusts to 1-1/4"

Knockouts:

- Rectangle: 2-1/4" x 3-7/8"

- 10 Pcs./Ctn.

- 3.4 Lbs./Ctn.

Uses: Faucets, Electrical Outlet

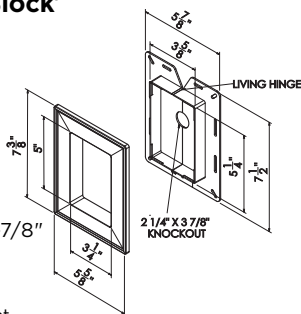

PLY GEM SHUTTERS | ACCENTS MOUNTING BLOCKS & UTILITY VENTS

DESCRIPTION & PACKAGING

COLOR AVAILABILITY

EBLOCK

For color availability, refer to list on page 59.

UL Electrical Block*

Mounting Surface:

- 5" x 6"

Projection:

- 2-1/8"

Trim Ring Dimensions:

- 7-1/8" x 8-1/8"

J-Channel I.D.:

- 1/2" adjusts to 1-1/4"

- 1 Pc./Ctn.

- 1 Lbs./Ctn.

* Includes UL approved black electrical box

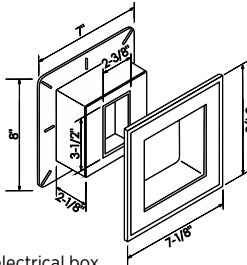

JMBLOCK

Large J-Block® Mounting Block

Mounting Surface:

- 6" x 10-1/8"

Trim Ring Dimensions:

- 8-3/8" x 12-1/2"

J-Channel I.D.:

- 1/2" adjusts to 1-1/4"

- 5 Pcs./Ctn.

- 4 Lbs./Ctn.

Uses: Light Fixtures, Mailbox,

House Numbers

Can be used with insulated siding.

Does not include electrical box.

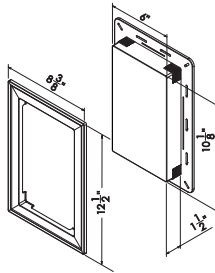

JMBLOCKSC

Large J-Block® Mounting Block with Scroll Cut Square

Mounting Surface:

- 6" x 10-1/8"

Trim Ring Dimensions:

- 8-3/8" x 12-1/2"

J-Channel I.D.:

- 1/2" adjusts to 1-1/4"

- 5 Pcs./Ctn.

- 4 Lbs./Ctn.

Uses: Light Fixtures, Mailbox,

House Numbers

Can be used with insulated siding.

Does not include electrical box.

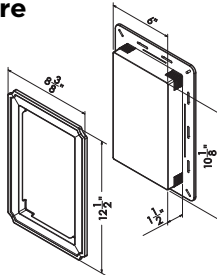

PLY GEM SHUTTERS | ACCENTS MOUNTING BLOCKS & UTILITY VENTS

DESCRIPTION & PACKAGING

COLOR AVAILABILITY

JMEBLOCK

Large J-Block® Mounting Block with UL Electrical Box*

Mounting Surface:

- 6" x 10-1/8"

Trim Ring Dimensions:

- 8-3/8" x 12-1/2"
- Adjusts 1/2" - 1-1/4"
- 4 Pcs./Ctn.
- 4.5 Lbs./Ctn.

* Includes UL approved black electrical box

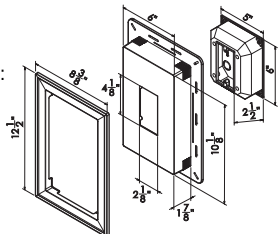

JMEBLOCKSC

Large J-Block® Mounting Block with UL Electrical Box Scroll Cut*

Mounting Surface:

- 6" x 10-1/8"

Trim Ring Dimensions:

- 8-3/8" x 12-1/2"
- Adjusts 1/2" - 1-1/4"
- 4 Pcs./Ctn.
- 4.5 Lbs./Ctn.

* Includes UL approved black electrical box

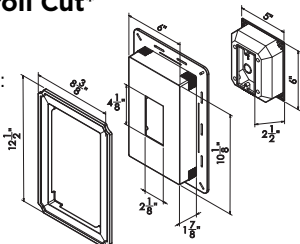

JMEOBLOCK

Large J-Block® Mounting Block with UL Electrical Box Offset*

Mounting Surface:

- 6" x 10-1/8"

Trim Ring Dimensions:

- 8-3/8" x 12-1/2"
- Adjusts 1/2" - 1-1/4"
- 4 Pcs./Ctn.
- 4.5 Lbs./Ctn.

* Includes UL approved black electrical box

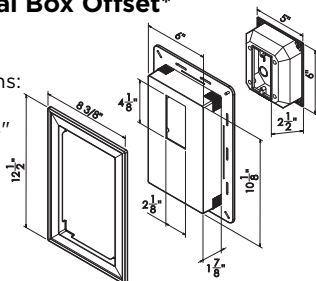

For color availability, refer to list on page 59.

PLY GEM SHUTTERS | ACCENTS MOUNTING BLOCKS & UTILITY VENTS

DESCRIPTION & PACKAGING

COLOR AVAILABILITY

JMEOBLOCKSC

Large J-Block® Mounting Block with UL Electrical Box Offset Scroll*

Mounting Surface:

- 6" x 10-1/8"

Trim Ring Dimensions:

- 8-3/8" x 12-1/2"

J-Channel I.D.:

- 1/2" adjusts to 1-1/4"

- 4 Pcs./Ctn.
- 4.5 Lbs./Ctn.

* Includes UL approved black electrical box

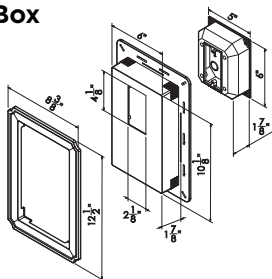

For color availability, refer to list on page 59.

UNIBLOCKXL

Large J-Block® Mounting Block

Mounting Surface:

- 9" x 16"

Trim Ring Dimensions:

- 11-3/4" x 18-3/4"

J-Channel I.D.:

- 1/2" adjusts to 1-1/4"

Knockouts:

- Round: 4" Diameter
- Rectangle: 2-3/8" x 3-3/4"

- 4 Pcs./Ctn.
- 5 Lbs./Ctn.

Uses: Light Fixtures, Mailbox, House Numbers

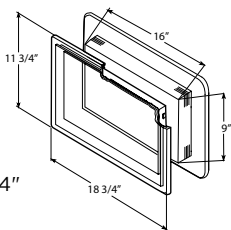

METERLG

Jumbo Meter Base J-Block®

Mounting Surface:

- 20" x 24"

Trim Ring Dimensions:

- 21-1/2" x 24-1/2"

J-Channel I.D.:

- 1/2" adjusts to 1-1/4"

- 1 Pcs./Ctn.
- 4 Lbs./Ctn.

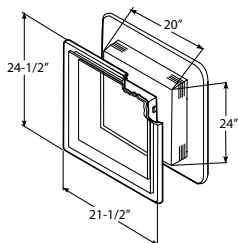

PLY GEM SHUTTERS | ACCENTS MOUNTING BLOCKS & UTILITY VENTS

DESCRIPTION & PACKAGING

COLOR AVAILABILITY

METER

Meter Base J-Block®

Mounting Surface:

- 16-1/2" x 15-1/2"

Flange Dimensions:

- 18-1/2" x 16-3/4"

J-Channel I.D.:

- 1-1/4"

- 5 Pcs./Ctn.

- 10 Lbs./Ctn.

Uses: Hose Rack, Electric Meter Base

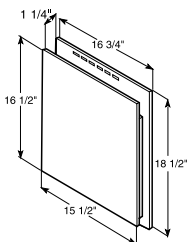

For color availability, refer to list on page 59.

PLY GEM SHUTTERS | ACCENTS MOUNTING BLOCKS & UTILITY VENTS

DESCRIPTION & PACKAGING

COLOR AVAILABILITY

EZBLK040

For color availability, refer to list on page 59.

Square Surface Mount (Double 4" or Double 5")

Surface Dimensions:

- 6-3/4" x 6-3/4"

Projections: 3/4"

Knockouts:

- Round: 1" Diameter
- Rectangle: 2-3/8" x 3-3/4"
- 10 Pcs./Ctn.
- 4 Lbs./Ctn.

Uses: Light Fixtures, Electrical Receptacles, Water Faucets

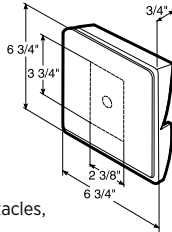

EZBLK070

Square Surface Mount (Dutch Lap)

Surface Dimensions:

- 6-3/4" x 6-3/4"

Projections: 3/4"

Knockouts:

- Round: 1" Diameter
- Rectangle: 2-3/8" x 3-3/4"
- 10 Pcs./Ctn.
- 4 Lbs./Ctn.

Uses: Light Fixtures, Electrical Outlets, Water Faucets

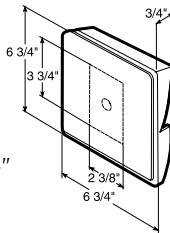

EZBLK080

Octagon Surface Mount (Double 4" or Double 5")

Surface Dimensions:

- 6-3/4" x 6-3/4"

Projections: 3/4"

Knockouts:

- Round: 1" Diameter
- Rectangle: 2-3/8" x 3-3/4"
- 10 Pcs./Ctn.
- 3.34 Lbs./Ctn.

Uses: Light Fixtures, Electrical Outlets, Water Faucets

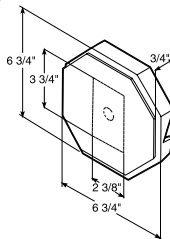

PLY GEM SHUTTERS | ACCENTS MOUNTING BLOCKS & UTILITY VENTS

DESCRIPTION & PACKAGING

COLOR AVAILABILITY

DRYERHOOD

4" Hooded Exhaust Vent System

Flange Dimensions:

- 6-5/8" x 6-5/8"

Hood Dimensions:

- 6-7/8" x 6-7/8"

- Neutral Base

J-Channel I.D.:

- 3/4" adjusts to 1-1/4"

- Tube Length: 10"

- Tube Diameter: 4"

- 1 System/Ctn.

- 1 Lb./Ctn.

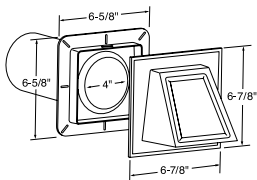

For color availability, refer to list on page 59.

DRYERHOOD6

6" Hooded Exhaust Vent System

Flange Dimensions:

- 9" x 9"

Hood Dimensions:

- 8-1/2" x 8-1/2"

J-Channel I.D.:

- 3/4" adjusts to 1-1/4"

- Tube Length: 10"

- Tube Diameter: 6"

- 1 System/Ctn.

- 1 Lb./Ctn.

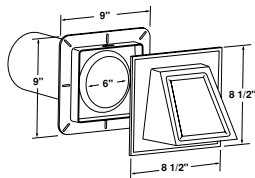

PLY GEM SHUTTERS | ACCENTS MOUNTING BLOCKS & UTILITY VENTS

DESCRIPTION & PACKAGING

COLOR AVAILABILITY

EXVENT

For color availability, refer to list on page 59.

Louvered Exhaust Vent

Flange Dimensions:

- 7-1/2" x 8-1/2"

Cap Dimensions:

- 7" x 7"

J-Channel I.D.:

- 3/4" adjusts to 1-1/4"

Net Free Area:

- 12.57 Sq. In.
- Tube Length: 10"
- Tube Diameter: 4"
- 1 System/Ctn.
- 1 Lb./Ctn.

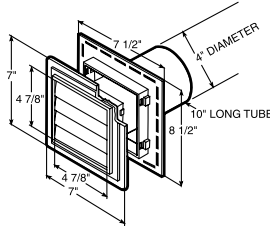

EXVENT6

6" Louvered Exhaust Vent

Flange Dimensions:

- 9-1/2" x 10-3/8"

Cap Dimensions:

- 9" x 9"

J-Channel I.D.:

- 3/4" adjusts to 1-1/4"

Net Free Area:

- 17.6 Sq. In.
- Tube Length: 10"
- Tube Diameter: 6"
- 1 System/Ctn.
- 1.2 Lb./Ctn.

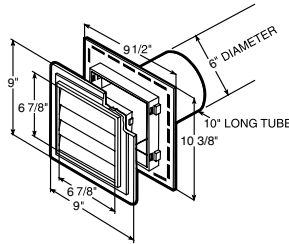

PLY GEM SHUTTERS | ACCENTS MOUNTING BLOCKS & UTILITY VENTS

DESCRIPTION & PACKAGING

COLOR AVAILABILITY

INTVENT

Intake/Exhaust Vent

Flange Dimensions:

- 7-1/2" x 7-1/2"

Cap Dimensions:

- 8" x 8"

J-Channel I.D.:

- 1/2" adjusts to 1-1/4"

Net Free Area:

- 12.3 Sq. In.
- Tube Length: 10"
- Tube Diameter: 4"

• 1 Pc./Ctn.

• 1 Lb./Ctn.

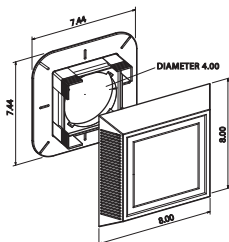

For color availability, refer to list on page 59.

FIRE HAZARD: NEVER use exhaust vent with screen for dryer ventilation. Flammable lint build-up on screen can cause a fire. Always use a vent that is specifically designed for dryer applications.

INTVENT6

6" Intake/Exhaust Vent

Flange Dimensions:

- 9-1/2" x 9-1/2"

Cap Dimensions:

- 10" x 10"

J-Channel I.D.:

- 1/2" adjusts to 1-1/4"

Net Free Area:

- 14.75 Sq. In.
- Tube Length: 10"
- Tube Diameter: 6"

• 1 Pc./Ctn.

• 1.2 Lb./Ctn.

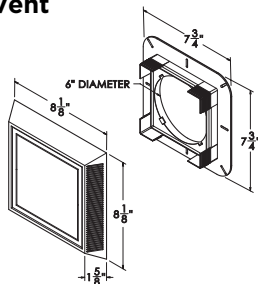

FIRE HAZARD: NEVER use exhaust vent with screen for dryer ventilation. Flammable lint build-up on screen can cause a fire. Always use a vent that is specifically designed for dryer applications.

FVENT

Foundation Vent

Flange Dimensions:

- 18-1/8" x 9-1/2"

Cap Dimensions:

- 16-7/8" x 8-3/4"

J-Channel I.D.:

- 3/4" adjusts to 1-1/4"

Net Free Area:

- 48 Sq. In.
- 10 Pc./Ctn.
- 11.94 Lb./Ctn.

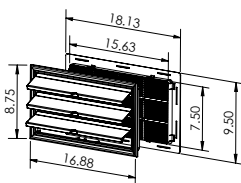

PLY GEM SHUTTERS | ACCENTS MOUNTING BLOCKS & UTILITY VENTS

DESCRIPTION & PACKAGING

COLOR AVAILABILITY

MHBLK1PW

Rectangular Block

Surface Dimensions:

- 7-3/4" x 7-3/4"

Rectangular Cutout:

- 2-1/2" x 3-3/4"
- 53 Pc./Ctn.

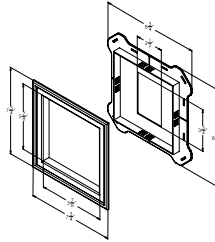

For color availability, refer to list on page 59.

MHBLK2 PW

Circle Cutout Block

Surface Dimensions:

- 7-3/4" x 7-3/4"

Circle Cutout:

- 4-1/8"
- 53 Pc./Ctn.

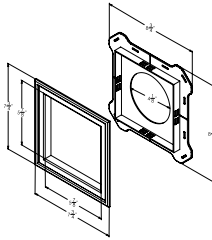

MHMBLOCKR PW

Split Recessed Block

Surface Dimensions:

- 5-1/4" x 7"

Flange Dimensions:

- 5-7/8" x 7-1/2"

J-Channel I.D.:

- 3/4" adjusts to 1-1/4"

Scored Knockout:

- 2-1/4" x 3-7/8" rectangle
- 4 Lbs./Ctn.
- 84 Pc./Ctn.

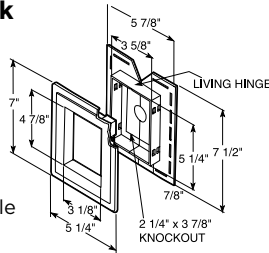

PLY GEM SHUTTERS | ACCENTS MOUNTING BLOCKS & UTILITY VENTS

DESCRIPTION & PACKAGING

COLOR AVAILABILITY

MHMVENT PW

Microwave Vent (with tube)

Surface Dimensions:

- 12-3/8" x 5-5/8"
- Tube Included
- 14 Pc./Ctn.

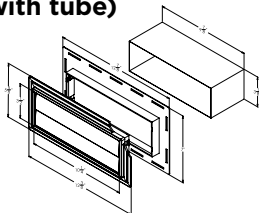

For color availability, refer to list on page 59.

MHDVENT PW

Dryer Vent

Surface Dimensions:

- 6-1/8" x 6-1/8"
- 56 Pc./Ctn.

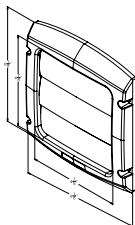

MCDVENT2 PW

Dryer Vent - 2 Piece

Surface Dimensions:

- 6-1/8" x 6-1/8"
- 40 Pc./Ctn.

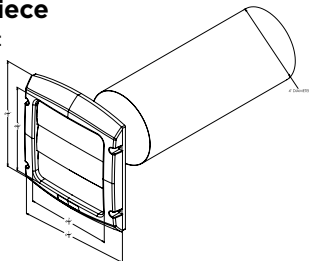

PLY GEM SHUTTERS | ACCENTS MOUNTING BLOCKS & UTILITY VENTS

DESCRIPTION & PACKAGING

COLOR AVAILABILITY

RDGV18

18" Round Gable Vent

Siding Receiver:

- 3/4" - 1-1/4"
in 1/8" increments

Net Free Area:

- 48.36 Sq. In.
- 1 Pc./Ctn.
- 2.3 Lbs./Ctn.

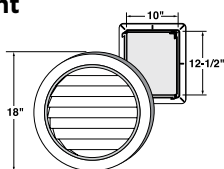

For color availability, refer to list on page 59.

RDGV

22" Round Gable Vent

Siding Receiver:

- 3/4" - 1-1/4"
in 1/8" increments

Net Free Area:

- 48.37 Sq. In.
- 1 Pc./Ctn.
- 4.1 Lbs./Ctn.

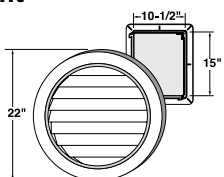

RDGV36

36" Round Gable Vent

Siding Receiver:

- 3/4" - 1-1/4"
in 1/8" increments

Net Free Area:

- 277.1 Sq. In.
- 1 Pc./Ctn.
- 8 Lbs./Ctn.

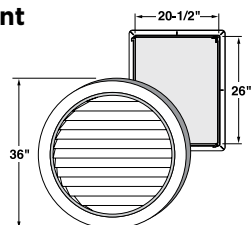

[Install gable vents](#)

PLY GEM SHUTTERS | ACCENTS MOUNTING BLOCKS & UTILITY VENTS

DESCRIPTION & PACKAGING

COLOR AVAILABILITY

OCTGV18

18" Octagon Gable Vent

Siding Receiver:

- 3/4" - 1-1/4"
in 1/8" increments

Net Free Area:

- 49.72 Sq. In.
- 1 Pc./Ctn.
- 2.4 Lbs./Ctn.

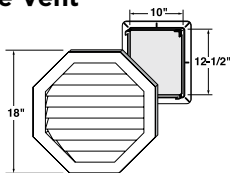

For color availability, refer to list on page 59.

OCTGV

22" Octagonal Gable Vent

Siding Receiver:

- 3/4" - 1-1/4"
in 1/8" increments

Net Free Area:

- 49.5 Sq. In.
- 1 Pc./Ctn.
- 5 Lbs./Ctn.

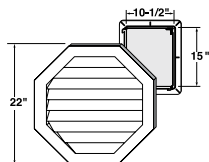

HRDGV

22" Half Round Gable Vent

Siding Receiver:

- 3/4" - 1-1/4"
in 1/8" increments

Net Free Area:

- 80.46 Sq. In.
- 1 Pc./Ctn.
- 8 Lbs./Ctn.

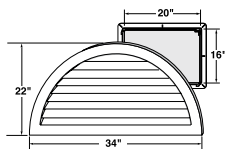

PLY GEM SHUTTERS | ACCENTS MOUNTING BLOCKS & UTILITY VENTS

DESCRIPTION & PACKAGING

COLOR AVAILABILITY

RDTOPGV14

For color availability, refer to list on page 59.

14" x 22" Round Top

Gable Vent

Siding Receiver:

- 3/4" - 1-1/4"
in 1/8" increments

Net Free Area:

- 53.17 Sq. In.
- 1 Pc./Ctn.
- 2.7 Lbs./Ctn.

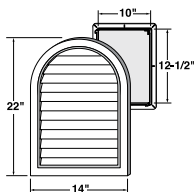

RDTOPGV24

24" x 34" Round Top Gable Vent

Siding Receiver:

- 3/4" - 1-1/4"
in 1/8" increments

Net Free Area:

- 191 Sq. In.
- 1 Pc./Ctn.
- 6 Lbs./Ctn.

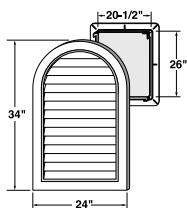

PLY GEM SHUTTERS | ACCENTS MOUNTING BLOCKS & UTILITY VENTS

DESCRIPTION & PACKAGING

COLOR AVAILABILITY

SQGV1414

For color availability, refer to list on page 59.

14" Square Gable Vent

Siding Receiver:

- 3/4" - 1-1/4"
in 1/8" increments

Net Free Area:

- 33.59 Sq. In.
- 1 Pc./Ctn.
- 2.3 Lbs./Ctn.

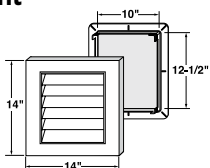

RECTGV

14" x 20" Rectangular Gable Vent

Siding Receiver:

- 3/4" - 1-1/4"
in 1/8" increments

Net Free Area:

- 23.29 Sq. In.
- 1 Pc./Ctn.
- 3.83 Lbs./Ctn.

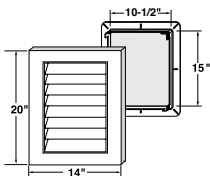

RECTGV1824

18" x 24" Rectangular Gable Vent

Siding Receiver:

- 3/4" - 1-1/4"
in 1/8" increments

Net Free Area:

- 92.88 Sq. In.
- 1 Pc./Ctn.
- 5.68 Lbs./Ctn.

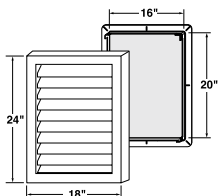

RECTGV2430

24" x 30" Rectangular Gable Vent

Siding Receiver:

- 3/4" - 1-1/4"
in 1/8" increments

Net Free Area:

- 181.2 Sq. In.
- 1 Pc./Ctn.
- 9 Lbs./Ctn.

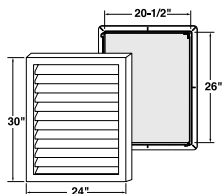

PLY GEM SHUTTERS

STANDARD 12" & 15" RAISED PANEL

DESCRIPTION & PACKAGING

COLOR AVAILABILITY

VINRP12

Standard Raised Panel Shutters

- 12" Wide (Nominal)
- High Density Copolymer
- Baked-on Acrylic Finish
- 1 Pair/Ctn.

Product Code	Length	Lbs./Ctn.
VINRP1227	27"	6 Lbs./Ctn.
VINRP1231	31"	7 Lbs./Ctn.
VINRP1235	35"	8 Lbs./Ctn.
VINRP1239	39"	8 Lbs./Ctn.
VINRP1243	43"	9 Lbs./Ctn.
VINRP1247	47"	10 Lbs./Ctn.
VINRP1251	51"	11 Lbs./Ctn.
VINRP1255	55"	12 Lbs./Ctn.
VINRP1259	59"	12 Lbs./Ctn.
VINRP1263	63"	13 Lbs./Ctn.
VINRP1267	67"	13 Lbs./Ctn.
VINRP1271	71"	15 Lbs./Ctn.

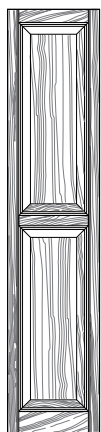

Regular Style

- 11 White
- 33 Black
- 99 Blackwatch Green
- 41 Blue
- 59 Brown
- BLU Coastal Blue
- IJ Dark Berry
- 95 Dark Navy
- 56 Dark Spruce
- 55 Green
- 16 Grey
- 52 Pebblestone Clay
- PE Peppercorn
- 38 Red
- CRM Sand Dollar
- 93 Spanish Moss
- SL Terra Brown
- SK Vineyard Red
- 58 Winestone

SHERWIN-WILLIAMS®

- EGF Evergreen Fog, SW 9130
- GAF Gale Force, SW 7605
- URB Urbane Bronze, SW 7048

VINRP15

Standard Raised Panel Shutters

- 15" Wide (Nominal)
- High Density Copolymer
- Baked-on Acrylic Finish
- 1 Pair/Ctn.

Product Code	Length	Lbs./Ctn.
VINRP1531	31"	6 Lbs./Ctn.
VINRP1535	35"	7 Lbs./Ctn.
VINRP1539	39"	8 Lbs./Ctn.
VINRP1543	43"	8 Lbs./Ctn.
VINRP1547	47"	9 Lbs./Ctn.
VINRP1551	51"	10 Lbs./Ctn.
VINRP1555	55"	10 Lbs./Ctn.
VINRP1559	59"	11 Lbs./Ctn.
VINRP1563	63"	12 Lbs./Ctn.
VINRP1567	67"	13 Lbs./Ctn.
VINRP1567C	67"	13 Lbs./Ctn.
VINRP1571	71"	13 Lbs./Ctn.
VINRP1575	75"	14 Lbs./Ctn.
VINRP1581	81"	15 Lbs./Ctn.

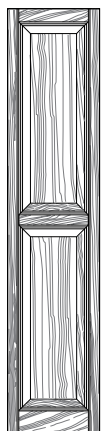

Regular Style

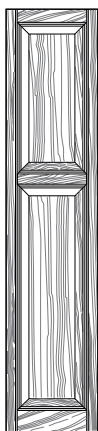

Cottage Style
(67" Length only)

Notes: All shutter dimensions are nominal. All louvered and raised panel shutter cartons include 3" painted steel mounting screws and shutter plugs.

Sherwin-Williams® is a registered trademark of SWIMC LLC.



[Installing Shutters](#)

PLY GEM SHUTTERS STANDARD 12" & 15" LOUVERED

DESCRIPTION & PACKAGING

COLOR AVAILABILITY

VINLV12

Standard Open Louvered Shutters

- 12" Wide (Nominal)
- High Density Copolymer
- Baked-on Acrylic Finish
- 1 Pair/Ctn.

Product Code	Length	Lbs./Ctn.
VINLV1255	55"	12 Lbs./Ctn.
VINLV1259	59"	12 Lbs./Ctn.



Regular Style

- 11 White
- 33 Black
- 99 Blackwatch Green
- 41 Blue
- 59 Brown
- BLU Coastal Blue
- IJ Dark Berry
- 95 Dark Navy
- 56 Dark Spruce
- 55 Green
- 16 Grey
- 52 Pebblestone Clay
- PE Peppercorn
- 38 Red
- CRM Sand Dollar
- 93 Spanish Moss
- SL Terra Brown
- SK Vineyard Red
- 58 Winestone

SHERWIN-WILLIAMS®

- EGF Evergreen Fog,
SW 9130
- GAF Gale Force,
SW 7605
- URB Urbane Bronze,
SW 7048

VINLV15

Standard Open Louvered Shutters

- 15" Wide (Nominal)
- High Density Copolymer
- Baked-on Acrylic Finish
- 1 Pair/Ctn.

Product Code	Length	Lbs./Ctn.
VINLV1525	25"	5 Lbs./Ctn.
VINLV1531	31"	6 Lbs./Ctn.
VINLV1535	35"	7 Lbs./Ctn.
VINLV1539	39"	7 Lbs./Ctn.
VINLV1543	43"	8 Lbs./Ctn.
VINLV1547	47"	8 Lbs./Ctn.
VINLV1551	51"	9 Lbs./Ctn.
VINLV1555	55"	11 Lbs./Ctn.
VINLV1559	59"	11 Lbs./Ctn.
VINLV1563	63"	11 Lbs./Ctn.
VINLV1567	67"	12 Lbs./Ctn.
VINLV1567C	67"	12 Lbs./Ctn.
VINLV1571	71"	12 Lbs./Ctn.
VINLV1575	75"	14 Lbs./Ctn.
VINLV1581	81"	14 Lbs./Ctn.



Regular Style



Cottage Style
(67" Length only)

Notes: All shutter dimensions are nominal. All louvered and raised panel shutter cartons include 3" painted steel mounting screws and shutter plugs.

Sherwin-Williams® is a registered trademark of SWIMC LLC.

PLY GEM SHUTTERS STANDARD 11" & 12" BOARD+BATTEN

DESCRIPTION & PACKAGING

COLOR AVAILABILITY

VIN3C11 & VIN3012

Standard Board+Batten 3-Board Shutters

- 11" -12" Wide (Nominal)
- High Density Copolymer
- Baked-on Acrylic Finish
- 1 Pair/Ctn.

CLOSED

Product Code	Length	Lbs./Ctn.
VIN3C1131	11"x31"	4.5 Lbs./Ctn.
VIN3C1135	11"x35"	5 Lbs./Ctn.
VIN3C1139	11"x39"	5 Lbs./Ctn.
VIN3C1143	11"x43"	5.5 Lbs./Ctn.
VIN3C1147	11"x47"	6 Lbs./Ctn.
VIN3C1151	11"x51"	6 Lbs./Ctn.
VIN3C1155	11"x55"	7 Lbs./Ctn.
VIN3C1159	11"x59"	7.5 Lbs./Ctn.
VIN3C1163	11"x63"	8 Lbs./Ctn.
VIN3C1167	11"x67"	8.5 Lbs./Ctn.
VIN3C1171	11"x71"	9 Lbs./Ctn.
VIN3C1175	11"x75"	9 Lbs./Ctn.
VIN3C1181	11"x81"	10 Lbs./Ctn.

OPEN

Product Code	Length	Lbs./Ctn.
VIN301231	12"x31"	4.5 Lbs./Ctn.
VIN301235	12"x35"	5 Lbs./Ctn.
VIN301239	12"x39"	5 Lbs./Ctn.
VIN301243	12"x43"	6 Lbs./Ctn.
VIN301247	12"x47"	6 Lbs./Ctn.
VIN301251	12"x51"	6.5 Lbs./Ctn.
VIN301255	12"x55"	7.5 Lbs./Ctn.
VIN301259	12"x59"	8 Lbs./Ctn.
VIN301263	12"x63"	8 Lbs./Ctn.
VIN301267	12"x67"	8.5 Lbs./Ctn.
VIN301271	12"x71"	9 Lbs./Ctn.
VIN301275	12"x75"	9.5 Lbs./Ctn.
VIN301281	12"x81"	10 Lbs./Ctn.



Closed
Style



Open Style

- 11 White
- 33 Black
- 99 Blackwatch Green
- 41 Blue
- 59 Brown
- BLU Coastal Blue
- IJ Dark Berry
- 95 Dark Navy
- 56 Dark Spruce
- 55 Green
- 16 Grey
- 52 Pebblestone Clay
- PE Peppercorn
- 38 Red
- CRM Sand Dollar
- 93 Spanish Moss
- SL Terra Brown
- SK Vineyard Red
- 58 Winestone

SHERWIN-WILLIAMS®

- EGF Evergreen Fog,
SW 9130
- GAF Gale Force,
SW 7605
- URB Urbane Bronze,
SW 7048

Notes: All shutter dimensions are nominal. Board+Batten shutter cartons include steel mounting screws.

Lengths 51" and smaller have 2 horizontal boards.
Lengths 55" and longer have 3 horizontal boards.

Sherwin-Williams® is a registered trademark of SWIMC LLC.

PLY GEM SHUTTERS

STANDARD 15" & 16" BOARD+BATTEN

DESCRIPTION & PACKAGING

COLOR AVAILABILITY

VIN4C15 & VIN4O16

Standard Board+Batten 4-Board Shutters

- 15" -16" Wide (Nominal)
- High Density Copolymer
- Baked-on Acrylic Finish
- 1 Pair/Ctn.

CLOSED

Product Code	Length	Lbs./Ctn.
VIN4C1531	15"x31"	6 Lbs./Ctn.
VIN4C1535	15"x35"	6.5 Lbs./Ctn.
VIN4C1539	15"x39"	7 Lbs./Ctn.
VIN4C1543	15"x43"	7.5 Lbs./Ctn.
VIN4C1547	15"x47"	8 Lbs./Ctn.
VIN4C1551	15"x51"	8.5 Lbs./Ctn.
VIN4C1555	15"x55"	10 Lbs./Ctn.
VIN4C1559	15"x59"	10 Lbs./Ctn.
VIN4C1563	15"x63"	10.5 Lbs./Ctn.
VIN4C1567	15"x67"	11 Lbs./Ctn.
VIN4C1571	15"x71"	11.5 Lbs./Ctn.
VIN4C1575	15"x75"	12 Lbs./Ctn.
VIN4C1581	15"x81"	13 Lbs./Ctn.

OPEN

Product Code	Length	Lbs./Ctn.
VIN4O1631	16"x31"	6 Lbs./Ctn.
VIN4O1635	16"x35"	6.5 Lbs./Ctn.
VIN4O1639	16"x39"	7 Lbs./Ctn.
VIN4O1643	16"x43"	7.5 Lbs./Ctn.
VIN4O1647	16"x47"	8 Lbs./Ctn.
VIN4O1651	16"x51"	8.5 Lbs./Ctn.
VIN4O1655	16"x55"	10 Lbs./Ctn.
VIN4O1659	16"x59"	10.5 Lbs./Ctn.
VIN4O1663	16"x63"	11 Lbs./Ctn.
VIN4O1667	16"x67"	11.5 Lbs./Ctn.
VIN4O1671	16"x71"	12 Lbs./Ctn.
VIN4O1675	16"x75"	12.5 Lbs./Ctn.
VIN4O1681	16"x81"	13 Lbs./Ctn.



Closed Style



Open Style

- 11 White
- 33 Black
- 99 Blackwatch Green
- 41 Blue
- 59 Brown
- BLU Coastal Blue
- IJ Dark Berry
- 95 Dark Navy
- 56 Dark Spruce
- 55 Green
- 16 Grey
- 52 Pebblestone Clay
- PE Peppercorn
- 38 Red
- CRM Sand Dollar
- 93 Spanish Moss
- SL Terra Brown
- SK Vineyard Red
- 58 Winestone

SHERWIN-WILLIAMS®

- EGF Evergreen Fog, SW 9130
- GAF Gale Force, SW 7605
- URB Urbane Bronze, SW 7048

Notes: All shutter dimensions are nominal. Board+Batten shutter cartons include steel mounting screws.

Lengths 51" and smaller have 2 horizontal boards.
Lengths 55" and longer have 3 horizontal boards.

The following lengths of VIN4C are molded panels - 47", 55", 59", 63", and 71".

Sherwin-Williams® is a registered trademark of SWIMC LLC.

PLY GEM SHUTTERS

ARCHED TOP 14" BOARD+BATTEN

DESCRIPTION & PACKAGING

BBARCH

Arch Top Board+Batten Shutter

- 14" Wide (Nominal)
- High Density Copolymer
- Baked-on Acrylic Finish
- 1 Pair/Ctn.

Product Code	Length	Lbs./Ctn.
BBARCH41	41"	7 Lbs./Ctn.
BBARCH43	43"	7.5 Lbs./Ctn.
BBARCH47	47"	8 Lbs./Ctn.
BBARCH57	57"	9.5 Lbs./Ctn.
BBARCH61	61"	10 Lbs./Ctn.
BBARCH65	65"	10.5 Lbs./Ctn.
BBARCH71	71"	11.5 Lbs./Ctn.
BBARCH73	73"	12 Lbs./Ctn.
BBARCH77	77"	12.5 Lbs./Ctn.
BBARCH85	85"	13 Lbs./Ctn.

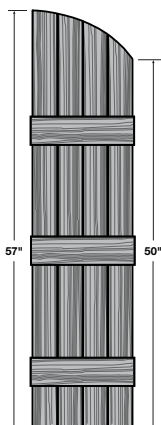

COLOR AVAILABILITY

- 11 White
- 33 Black
- 99 Blackwatch Green
- 41 Blue
- 59 Brown
- BLU Coastal Blue
- IJ Dark Berry
- 95 Dark Navy
- 56 Dark Spruce
- 55 Green
- 16 Grey
- 52 Pebblestone Clay
- PE Peppercorn
- 38 Red
- CRM Sand Dollar
- 93 Spanish Moss
- SL Terra Brown
- SK Vineyard Red
- 58 Winestone

SHERWIN-WILLIAMS®

- EGF Evergreen Fog,
SW 9130
- GAF Gale Force,
SW 7605
- URB Urbane Bronze,
SW 7048



[Installing Shutters](#)

Notes: All shutter dimensions are nominal. Board+Batten shutter cartons include steel mounting screws.

Sherwin-Williams® is a registered trademark of SWIMC LLC.

DESCRIPTION & PACKAGING

COLOR AVAILABILITY

Custom Open Louvered Panel Shutters

- 9", 12" or 15" Wide (Nominal)
- High Density Copolymer
- Baked-on Acrylic Finish
- 1 Pair/Ctn.

Product Code

Example: CLV1530

CLV1530 = CLV + width + length

Custom Louvered Panel = CLV

Width = 15"

Length = 30"



Regular Style

11	White
33	Black
99	Blackwatch Green
41	Blue
59	Brown
BLU	Coastal Blue
IJ	Dark Berry
95	Dark Navy
56	Dark Spruce
55	Green
16	Grey
52	Pebblestone Clay
PE	Peppercorn
38	Red
CRM	Sand Dollar
93	Spanish Moss
SL	Terra Brown
SK	Vineyard Red
58	Winestone

Custom Raised Panel Shutters

- 12" or 15" Wide (Nominal)
- High Density Copolymer
- Baked-on Acrylic Finish
- 1 Pair/Ctn.

Product Code

Example: CRP1530

CRP1530 = CRP + width + length

Custom Raised Panel = CRP

Width = 15"

Length = 30"

Lengths available: 18"-96"

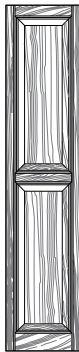

Regular Style

SHERWIN-WILLIAMS®

EGF Evergreen Fog,
SW 9130

GAF Gale Force,
SW 7605

URB Urbane Bronze,
SW 7048

Notes: All shutter dimensions are nominal. All louvered and raised panel shutter cartons include 3" painted steel mounting screws and shutter plugs.

Sherwin-Williams® is a registered trademark of SWIMC LLC.

PLY GEM SHUTTERS ACCESSORIES

DESCRIPTION & PACKAGING

COLOR AVAILABILITY

ARCH15RP

15" Raised Panel Arch Top

- 1 Pair/Ctn.
- 3 Lbs./Ctn.

* For standard shutters only

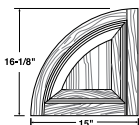

TRANRP15

15" Raised Panel Transom Top

- 1 Pair/Ctn.
- 3 Lbs./Ctn.

* For standard shutters only

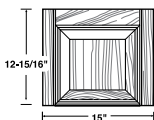

Notes: All shutter dimensions are nominal. All louvered and raised panel shutter cartons include 3" painted steel mounting screws and shutter plugs.

Not for use with custom shutters

ARCH15LV

15" Open Louvered Arch Top

- 1 Pair/Ctn.
- 3 Lbs./Ctn.

* For standard shutters only

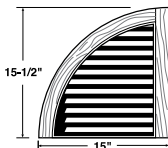

- 11 White
- 33 Black
- 99 Blackwatch Green
- 41 Blue
- 59 Brown
- BLU Coastal Blue
- IJ Dark Berry
- 95 Dark Navy
- 56 Dark Spruce
- 55 Green
- 16 Grey
- 52 Pebblestone Clay
- PE Peppercorn
- 38 Red
- CRM Sand Dollar
- 93 Spanish Moss
- SL Terra Brown
- SK Vineyard Red
- 58 Winestone

SHERWIN-WILLIAMS®

- EGF Evergreen Fog,
SW 9130
- GAF Gale Force,
SW 7605
- URB Urbane Bronze,
SW 7048

Sherwin-Williams® is a registered trademark of SWIMC LLC.

PLY GEM SHUTTERS ACCESSORIES

DESCRIPTION & PACKAGING

COLOR AVAILABILITY

SHUTTRPLUG

Fastener

- 1/4" x 2-5/8"
- 12 Pcs./Pkg.

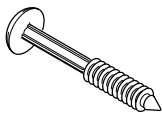

- 11 White
- 33 Black
- 99 Blackwatch Green
- 41 Blue
- 59 Brown
- BLU Coastal Blue
- IJ Dark Berry
- 95 Dark Navy
- 56 Dark Spruce
- 55 Green
- 16 Grey
- 52 Pebblestone Clay
- PE Peppercorn
- 38 Red
- CRM Sand Dollar
- 93 Spanish Moss
- SL Terra Brown
- SK Vineyard Red
- 58 Winestone

VINITT

Painted Steel Replacement Screws

- 3/16" x 3"
- 4 Pcs./Pkg.



SHERWIN-WILLIAMS®

- EGF Evergreen Fog,
SW 9130
- GAF Gale Force,
SW 7605
- URB Urbane Bronze,
SW 7048

SHTCLP12

Mill Finish

Shutter Clips and Anchors

- 12 Pc. = 1 Each
- 50 Each = 1 Ctn.

* For standard shutters only.



SHOOK

33 Black

Hooks and Hinges

Includes:

- (4) Hinges,
- (2) S-Hooks
(right and left)
- (10) Screws

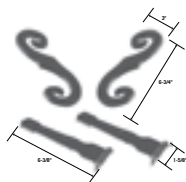

Sherwin-Williams® is a registered trademark of SWIMC LLC.

PLY GEM WINDOW MANTELS

DESCRIPTION & PACKAGING

COLOR AVAILABILITY

PEDIMENTST

Pediment Set

- Pediment Height: 12-3/4"
- Overall Height: 18-1/2"
- 1 Pc./Ctn.
- 8 Lbs./Ctn.

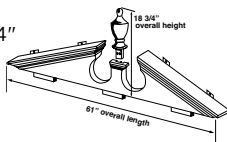

See the Color Matrix on page 63.

MANTEL

Door Surround Mantel

- Length: 58"
- 1 Pc./Ctn.
- 7.41 Lbs./Ctn.

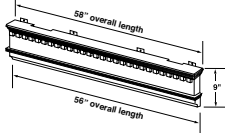

MANTELOVLY

Door Mantel Overlay

- Length: 10-1/2"
- 6 Pcs./Ctn.
- 6.24 Lbs./Ctn.

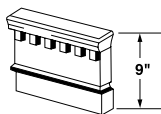

TOPCAP

Pilaster Cap

- 1 Pc./Ctn.
- .23 Lb./Ctn.

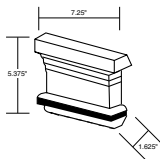

BASECAP

Pilaster Base

- 1 Pc./Ctn.
- .56 Lb./Ctn.

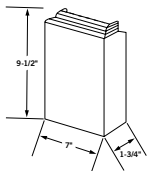

[Installing door
surrounds](#)

DESCRIPTION & PACKAGING

COLOR AVAILABILITY

PILASTER96

96" Pilaster Set

- 2 Pilasters
- 6 Mounting Clips
- 2 Pilaster Caps
- 2 Pilaster Bases
- Width: 7-1/2"
- Height: 96"
- 1 Pair/Ctn.
- 15.49 Lbs./Ctn.

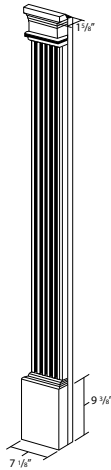

See the Color Matrix on page 63.

PILASTER144

144" Pilaster Set

- 2 Pilasters
- 6 Mounting Clips
- 2 Pilaster Caps
- 2 Pilaster Bases
- Width: 7-1/2"
- Height: 144"
- 1 Pair/Ctn.
- 19.71 Lbs./Ctn.

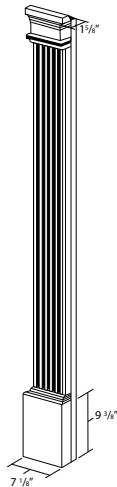

PLY GEM WINDOW MANTELS

DESCRIPTION & PACKAGING

COLOR AVAILABILITY

MANTEL120

See the Color Matrix on page 63.

120" Mantel System

Mantel:

- Face Height: 7-3/8"
- Length: 120"

Plain Cover Strip:

- Height: 1"
- Length: 120"
- Thickness: .139

Mantel System Includes:

- 1 - Mantel (120")
- 1 - Plain Cover Strip (120")
- 16 - (8) Anchors and (8) Screw/Washers
- 1 Mantel System/Ctn.
- 15.25 Lbs./Ctn.

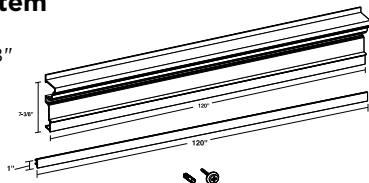

DENTILSTP

60" Dentil Strip

- Height: 1"
- Length: 60"
- 2 Pcs./Ctn.
- 2.4 Lbs./Ctn.

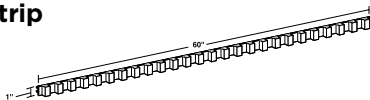

KEYSTN

Keystone for 120" Mantel System

- Height: 7-1/2"
- Top Width: 7"
- Bottom Length: 4-3/4"
- 1 Pc./Ctn.
- 1.26 Lb./Ctn.

(includes mounting hardware)

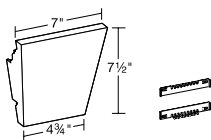

SDGENDCAP

Siding Endcaps for 120" Mantel System

- Height: 7-3/8"
- Width: 3-1/4"
- 2 Pcs./Ctn.
- 2.98 Lbs./Ctn.

(includes adhesive)

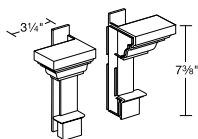

BRKENDCAP

Brick Endcaps for 120" Mantel System

- Height: 7-3/8"
- Width: 3-1/4"
- 2 Pcs./Ctn.
- 3.06 Lbs./Ctn.

(includes adhesive)

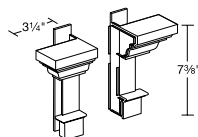

PLY GEM SHUTTERS ACCESSORIES

DESCRIPTION & PACKAGING

COLOR AVAILABILITY

36" 40" 44" Window Mantel

- Height: 7-1/4"
- 1 Pc./Ctn.

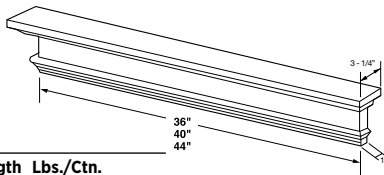

See the Color Matrix on page 63.

Product Code	Length	Lbs./Ctn.
PLWINMTL36	36"	6 Lbs./Ctn.
PLWINMTL40	40"	6.54 Lbs./Ctn.
PLWINMTL44	44"	7 Lbs./Ctn.

36" 40" 44" Window Mantel with Dentil Trim

- Height: 7-1/4"
- 1 Pc./Ctn.

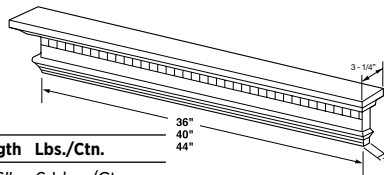

Product Code	Length	Lbs./Ctn.
DTWINMTL36	36"	6 Lbs./Ctn.
DTWINMTL40	40"	6.54 Lbs./Ctn.
DTWINMTL44	44"	7 Lbs./Ctn.

KEystone

Keystone

- Height: 8-3/4"
- Length: 7-3/4"
- 1 Lb./Ctn.
- 1 Pc./Ctn.

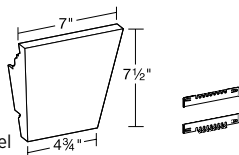

For use with window mantel

ENDCAP

Endcap for Window Mantel

- 1 Pc./Ctn.
- .82 Lb./Ctn.

(includes adhesive)

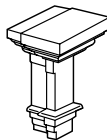

[Installing
10 foot mantle](#)

[Installing door
surrounds](#)



PLY GEM SHUTTERS | ACCENTS COLOR MATRIX

DESCRIPTION & PACKAGING

COLOR AVAILABILITY

Manufacturer	Code	Color
TRUEWALL	53	Almond
TRUEWALL	145	Bayou
TRUEWALL	EX	Beige
TRUEWALL	BK	Bayou
TRUEWALL	100	Briarwood/Maple*/Shaded Cedar*
TRUEWALL	812	Brunswick
TRUEWALL	S7	Cherry*
TRUEWALL	BQ	Chestnut*/Hearthstone Brown*
TRUEWALL	PC	Clay/Northern Oak*
TRUEWALL	30	Cream
TRUEWALL	246	Cypress
TRUEWALL	813	Dublin
TRUEWALL	ED	Flint/Shaded Gray*
TRUEWALL	02	Gray
TRUEWALL	290	Hampton Red
TRUEWALL	260	Hazelnut
TRUEWALL	814	Iron
TRUEWALL	BI	Mist
TRUEWALL	N5	Musket Brown
TRUEWALL	FQ	Oak*
TRUEWALL	511	Olive
TRUEWALL	IC	Palm
TRUEWALL	PP	Pearl
TRUEWALL	090	Pewter/Coastal Blue*/Ironwood*/Sycamore*
TRUEWALL	ID	Redwood*
TRUEWALL	170	Sagebrook/Mesquite*
TRUEWALL	144	Shadow
TRUEWALL	A7	Tan
TRUEWALL	IF	Teak
TRUEWALL	510	Thistle
TRUEWALL	390	Wedgewood
TRUEWALL	AW	White



[Mounthing block
and vent](#)

* Recommended solid match for variegated color.

DESCRIPTION & PACKAGING

COLOR AVAILABILITY

420-04

Solid Panel Deep Woodgrain Finish

- Length: 12' 0"
- 16" exposure
- 61 Lbs./Ctn.
- 12 Panels/Ctn.



White
Clay
Cream
Gray
Pearl
Tan

422-04

Center Vent Panel Basketweave Finish

- Length: 12' 0"
- 16" exposure
- 61 Lbs./Ctn.
- 12 Panels/Ctn.



PARKSIDE® SKIRTING ACCESSORIES

DESCRIPTION & PACKAGING

COLOR AVAILABILITY

471

Top Back Rail

- Length: 11' 6"
- 61 Lbs./Ctn.
- 28 Pc./Ctn. / 322 Ln. Ft.



White
Clay
Cream
Gray
Pearl
Tan

472

Hinge Style Top Front Rail

- Length: 11' 7-1/4"
- 61 Lbs./Ctn.
- 28 Pc./Ctn. / 328 Ln. Ft.



473

Bottom Rail

- Length: 11' 6"
- 58 Lbs./Ctn.
- 28 Pc./Ctn. / 322 Ln. Ft.



513

Skirting Hardware

- Length: 250 1"
- Attachment Screws
and 125 Ground Spikes per carton



N/A

456

Hinge Style Trim Pack

- 108 Lbs./Ctn.
- 14 pieces each: Top Back, Front and
Bottom Rails
- 250 - Screws
- 125 - 7" Spikes

White
Clay
Cream
Gray
Pearl
Tan

457

Wind Resistant Trim Pack

- 107.40 Lbs./Ctn.
- 14 pieces each: Top Back, Front and
Bottom Rails
- 250 - Screws
- 125 - 7" Spikes

APPLICATION TOOLS

DESCRIPTION & PACKAGING

COLOR AVAILABILITY

552

Snap Lock Punch

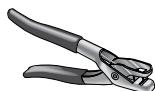

N/A

553

Unlocking Tool

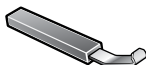

554

Nail Hole Punch



[How to cut
vinyl siding](#)

[How to use vinyl
siding specialty
tools](#)



METAL ACCESSORIES

DESCRIPTION & PACKAGING

COLOR AVAILABILITY

1WAP10 00

Mill Finish

Beaded Starter Strip

- Width: 2-1/8"
- Length: 10' 0"
- 27 Lbs./Ctn.
- 40 Pcs./Ctn.
- 250 Ft.

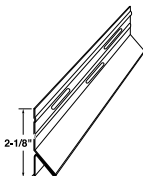

VSS10NS 00

Wide Aluminum Starter Strip

- Width: 2-1/2"
- Length: 10' 0"
- 32.7 Lbs./Ctn.
- 50 Pcs./Ctn.
- 500 Ft.

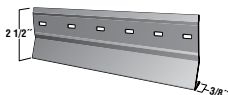

CPSSHD

Cedar Galvanized Steel Starter Strip

- Length: 10' 0"
- Galvanized Steel
- 49 Lbs./Ctn.
- 25 Pcs./Ctn.
- 250 Lin./Ft.

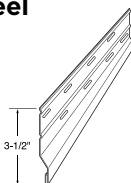

CDSS

Cedar Aluminum Starter Strip

- Length: 10' 0"
- 32 Lbs./Ctn.
- 50 Pcs./Ctn.
- 500 Ft.

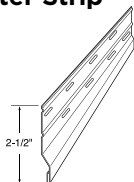

[Starter strip](#)

Notes:



The largest manufacturer of exterior building products in North America

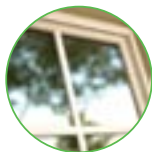

#1

Windows



#1

Vinyl Siding & Accessories



#1

Metal Roofing & Wall Systems



#1

Turnkey Stone
Installation Solutions



True to You. True to Your Craft.

The durability and natural beauty of TrueWall vinyl siding products are backed by a Limited Lifetime Transferable Warranty.*

Looking for the perfect finishing touch?

A complete line of color accessories adds the perfect finishing touch to any home. Create a unique statement by choosing a contrasting or matching accessory to complete the look of a virtually maintenance-free home.

Contact your distributor for actual product samples.

*Warranty: TrueWall products have TrueWall's Limited Lifetime Transferable Warranty that is backed by Variform, Inc. Consult the actual product warranty for complete coverage details.

5020 Weston Parkway • Cary, NC 2513

ASTM
D 3679



*Consult the VSI Web site at vinylsiding.org for a current list of qualified products and colors.

True to you. True to your craft. © 2024 TrueWall, Inc., part of **Cornerstone Building Brands, Inc.**
ALL RIGHTS RESERVED. Printed in the U.S.A. 450109501101/Rev1/M5/CG/0124