

VINYL SIDING  
AND SOFFIT



Product Guide



# TABLE OF CONTENTS

|   |       |
|---|-------|
| <b>Vinyl Siding Accessories Physical Properties</b> . . . . . | 5-7   |
| <b>Informational Video Links</b> . . . . .                    | 8-11  |
| <b>Series 5000</b>  |       |
| Double 6" . . . . .   | 12-13 |
| <b>Series 4400 II</b>   |       |
| Standard Lap . . . . .  | 14    |
| Dutch Lap . . . . .   | 14    |
| <b>Series 4400 Beaded</b>                                     |       |
| Single 6 1/2" . . . . .                                       | 14    |
| <b>Series 4200</b>  |       |
| Standard Lap . . . . .  | 15    |
| Dutch Lap . . . . .   | 15    |
| <b>Series 4010</b>  |       |
| Dutch Lap . . . . .   | 16    |
| <b>Series 4000</b>  |       |
| Standard Lap . . . . .  | 17    |
| Dutch Lap . . . . .   | 17    |
| <b>Series 3800</b>  |       |
| Standard Lap . . . . .  | 18    |
| Dutch Lap . . . . .   | 18    |
| <b>Series 4800</b> . . . . .                                  | 19    |
| <b>Series 9000</b> . . . . .                                  | 19    |
| <b>Double 5" Soffit</b> . . . . .                             | 20    |
| <b>Series 9100</b> . . . . .                                  | 21    |
| <b>Beaded Soffit</b> . . . . .                                | 22    |
| <b>Economy Triple 4" Soffit</b> . . . . .                     | 22-23 |

# TABLE OF CONTENTS

|  |       |
|--|-------|
| <b>Economy Double 5" Soffit</b> .....              | 23    |
| <b>Beaded Soffit Installation Components</b> ..... | 24    |
| <b>Soffit Installation Components</b> .....        | 24    |
| <b>Accent Panels &amp; Installation Components</b> |       |
| Series 1000 .....                                  | 25    |
| Shingle Siding .....                               | 25-26 |
| Round Cut Siding .....                             | 25-26 |
| Hand-Split Siding .....                            | 25-26 |
| Triple 5" Shingle .....                            | 26    |
| <b>Installation Components</b> .....               | 27-35 |
| <b>Ply Gem Shutters &amp; Accents</b>              |       |
| Mounting Blocks & Utility Vents .....              | 36-51 |
| Mounting Blocks .....                              | 36-47 |
| Gable Vents .....                                  | 48-51 |
| Shutters .....                                     | 52-59 |
| Window Mantels .....                               | 60-63 |
| Color Matrix .....                                 | 64    |
| <b>Parkside® Skirting</b> .....                    | 65    |
| <b>Parkside® Skirting Accessories</b> .....        | 66    |
| <b>Application Tools</b> .....                     | 67    |
| <b>Metal Accessories</b>                           |       |
| Starter Strips .....                               | 68    |

**TrueWall Vinyl Siding and Soffit products meet or exceed the following industry Standards and/or Building Code Approvals.**

| <b>Standards and Codes</b>            | <b>Report #</b>      |
|---------------------------------------|----------------------|
| ASTM                                  | C1363                |
| ASTM                                  | C272                 |
| ASTM                                  | D2843 (U.B.C. #52-2) |
| ASTM                                  | D3679                |
| ASTM                                  | D4226                |
| ASTM                                  | D4477                |
| ASTM                                  | D635                 |
| ASTM                                  | E84                  |
| ASTM                                  | E96                  |
| ICC Evaluation Service                | NER-638              |
| Metro Dade                            | 08-0429.11           |
| State of Florida                      | 5538-R1              |
| State of Florida                      | 11191                |
| State of Florida                      | 5544                 |
| State of Florida                      | 12141                |
| Texas State Board of Insurance Ruling | EC-27                |

Compound Cell Classification: Polyvinyl Chloride (PVC) compound is defined as 13344-B in conformance to ASTM D 1784 (1/8 inch Izod specimen).

Weathering: Environmental exposure testing conducted in three environments; dry, hot climate (Arizona), hot, humid climate (Florida) and northern temperate climate per ASTM D 3679.

Color Monitoring: Lot-to-lot color monitoring conducted by Spectrophotometer per Standard Test Procedure CQA332Q3.

Lock: Precision formed using post formed technique.

Product specifications are accurate as of the printing date of this specification sheet.

VSI Fire Statement: Rigid vinyl siding is made from organic materials and will melt or burn when exposed to a significant source of flame or heat. Building owners, occupants and outside maintenance personnel should always take normal precautions to keep sources of fire, such as barbecues and combustible materials, such as dry leaves, mulch and trash, away from vinyl siding.

For a complete listing of certified products and information about the fire properties of vinyl siding, contact the Vinyl Siding Institute, 1201 15th St. NW, Suite 220, Washington, D.C., 20005 or visit the VSI website at [vinylsiding.org](http://vinylsiding.org) for a current listing of certified products and colors.

**Extruded Polyvinyl Chloride (PVC) consisting exclusively of PVC compound with the following typical properties:**

| <b>Physical Properties</b>              | <b>TrueWall Vinyl Siding &amp; Soffit</b> | <b>ASTM Standard</b>     |
|---|---|--------------------------|
| Izod impact at 32°F, (ft. •lbF/in.)     | 1.9                                       | 0.65 min                 |
| Izod impact at 74°F, (ft. •lbF/in.)     | 3.3                                       | 2.4 min                  |
| Tensile strength, (psi)                 | 6,326                                     | 5,800                    |
| Tensile modulus, (psi)                  | 364,500                                   | 319,000 min              |
| Heat deflection Temp., (°F) @ 264 psi   | 167                                       | 158 min                  |
| Coefficient of linear thermal expansion | 3.3x10 <sup>-5</sup>                      | 4.5x10 <sup>-5</sup> max |
| Shore D hardness                        | 82  | n/a                      |
| Chemical resistance properties          | Excellent                                 | n/a                      |
| Flame spread index                      | 20.0                                      | 25.0                     |
| Smoke density developed                 | 275                                       | n/a                      |

**Premium Color Panels Only**

| <b>Physical Properties</b>              | <b>TrueWall Vinyl Siding &amp; Soffit</b> | <b>ASTM Standard</b>     |
|---|---|--------------------------|
| Tensile strength, (psi)                 | 6,090                                     | 5,800                    |
| Heat deflection Temp., (°F) @ 264 psi   | 167                                       | 158 min                  |
| Modules of elasticity (PSI)             | 363,795                                   | 310,000 min              |
| Izod impact at 32°F, (ft. •lbF/in.)     | 3.7                                       | 0.65 min                 |
| Izod impact at 74°F, (ft. •lbF/in.)     | 3.7                                       | 2.4 min                  |
| Shore D hardness                        | n/a                                       |                          |
| Coefficient of linear thermal expansion | 3.34x10 <sup>-5</sup>                     | 4.5x10 <sup>-5</sup> max |
| Chemical resistance properties          | Excellent                                 | n/a                      |
| Flame spread index                      |   | 25.0                     |
| Smoke density developed                 |   | n/a                      |

## Injection Molded Painted Polypropylene

| Physical Properties                       | TrueWall Vinyl Siding & Soffit  | ASTM Standard |
|---|---------------------------------|---------------|
| Panel color-thru                          | Yes                             |               |
| Panel coating                             | None, Paint (variegated colors) |               |
| Caliper of face                           | .101                            |               |
| Caliper of nail hem between slots         | .127                            |               |
| Gloss                                     | 10                              |               |
| Manufacturing Injection Physicals         | Molded Polypropylene            |               |
| Wind load test (-100PSF)                  | 195 m.p.h.                      | D5206-096     |
| Impact test (ft.-lbs./in.)                | 1.0                             | D 250         |
| Tensile strength (PSI)                    | 2,900                           | D 638         |
| Modules of elasticity (PSI)               | 340,000                         |               |
| Deflection Temp. under flexural load (°F) | 202                             | D648          |
| Linear thermal expansion                  | 1/16" per 30°F                  | D698          |
| Flame spread index                        | 95                              | E 84-84       |

## Technical Specifications

| Physical Properties    | Design Pressure (DP) | Reference 30' Building Zone B Wind Velocity |
|------------------------|----------------------|---|
| Series 5000            | 68.9 PSF             | 180 MPH                                     |
| Series 4400 II         | 89.4 PSF             | 190 MPH                                     |
| Series 4200            | 56 PSF               | 160 MPH                                     |
| Series 4400 Beaded     | 51 PSF               | 155 MPH                                     |
| Series 4010            | 56 PSF               | 160 MPH                                     |
| Series 4000            | 40 PSF               | 145 MPH                                     |
| Series 3800            | 56 PSF               | 160 MPH                                     |
| Series 1000 Shingle    | 73.3 PSF             | 180 MPH                                     |
| Series 1000 Hand-Split | 82.2 PSF             | 185 MPH                                     |
| Series 1000 Round Cut  | 48.9 PSF             | 140 MPH                                     |

### Compliance

TrueWall vinyl siding is listed in the National Evaluation Report-460. N.E.R.-460 and is recognized by SBCCI (Southern Builders Code Congress International), ICBO (International Conference of Building Officials) and BOCA (Building Officials and Code Administrators International).

TrueWall Vinyl Siding and Soffit is in conformance with ASTM D 3679, "Standard Specification for Rigid Polyvinyl Chloride (PVC) Siding."

# INFORMATIONAL VIDEO LINKS

## Accessing Our Training Videos

Watch our quick, user-friendly videos linked below to learn more about our products and installation techniques. You can access the videos by using the camera app on your smartphone or tablet to scan the QR codes below. Then click on the pop-up bar to open the

video. If you are accessing this page electronically and the video name is highlighted in blue, you can click on the name to watch the video. Once the video link opens, you can change the language and speed of the video by clicking on the setting gear in the bottom right corner.

## General Siding Info



[Estimating a project](#)



[J-Channel options](#)



[How to cut vinyl siding](#)



[Flash an existing window with vinyl](#)



[How to use vinyl siding specialty tools](#)



[Install water/wall diverters](#)



[Starter strip](#)



[Field forming trim sheet](#)

## Vinyl Siding



[Vinyl siding profile options](#)



[Transitioning from horizontal siding](#)



[Installing vinyl siding panels](#)



[Installing long length panels](#)



# INFORMATIONAL VIDEO LINKS

---

## Vinyl Siding (continued)



[Foam insulated siding options](#)



[Install horizontal beaded siding](#)



[Foam-backed siding options](#)

---

## Vertical Siding



[Vertical siding options](#)



[Installing vertical siding](#)

---

## Corner Posts



[Corner post options](#)



[Overlapping and closing off outside corners](#)



[Flashing and installing corner posts](#)



[Replacing panels and outside corners](#)

---

## Lineals



[Install lineals around new & remodeled windows](#)



[Install lineals as band boards and gables](#)

---

## Gables



[Developing a pattern for cutting panels in gables](#)



[Horizontal siding — last course in eave & gable](#)

# INFORMATIONAL VIDEO LINKS

---

## Soffits



[Soffit options](#)



[Installing porch ceilings/beaded soffit](#)



[Installing vinyl soffits](#)

---

## Fascia



[Aluminum fascia covers and bird boxes](#)



[Optional aluminum fascia covers](#)

---

## Accents, Blocks, Vents & Accessories



[Install mounting blocks and fixture vents](#)



[Installing door surrounds](#)



[Install gable vents](#)



[Installing 10 foot mantle](#)



[Designer accents](#)



[Installing shutters](#)

## Cedar



[Cedar panels and accessories](#)



[Cedar panels - last panel in eave & gable](#)



[Install cedar panels](#)



[How to replace a cedar panel](#)

# SERIES 5000

## DESCRIPTION & PACKAGING

## COLOR AVAILABILITY

108

### Double 6" Traditional

- 12' 6" Panel
- 62 Lbs./Ctn.
- 8 Pc./Ctn.
- 1 Sq./Ctn.
- 1-1/8" overall thickness
- Thickness: .044
- 9 Sq./Crate



#### Standard Colors

White  
Almond  
Cream  
Gray  
Mist  
Tan

#### Dark Colors\*

Clay  
Flint  
Thistle

#### Premium Dark Colors\*

Briarwood  
Pewter  
Sagebrook  
Wedgewood

300

### Window & Door Surround

- Length: 12' 6"
- 39.48 Lbs./Ctn.
- 10 Pc./Ctn.

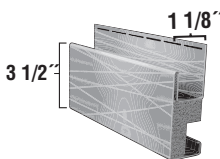

#### Standard Colors

White  
Almond  
Cream  
Gray  
Mist  
Tan

#### Dark Colors\*

Clay  
Flint  
Thistle

352

### Outside Corner Post

- Length: 12' 0"
- 55.88 Lbs./Ctn.
- 10 Pc./Ctn.

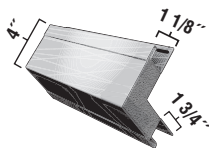

#### Standard Colors

White  
Almond  
Cream  
Gray  
Mist  
Tan

#### Dark Colors\*

Clay  
Flint  
Thistle

#### Premium Dark Colors\*

Briarwood  
Pewter  
Sagebrook  
Wedgewood

359

### Inside Corner Post

- Length: 12' 0"
- 29.54 Lbs./Ctn.
- 10 Pc./Ctn.

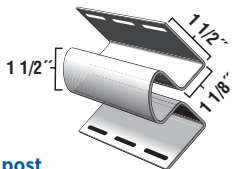

[Corner post options](#)



[Flashing and installing corner posts](#)

[Installing vinyl siding panels](#)



[Replacing panels and outside corners](#)



\* Upcharge applies.

## DESCRIPTION & PACKAGING

## COLOR AVAILABILITY

40023

### 1-1/4" J-Channel

- Length: 12' 6"
- 12' 6" Panel
- 63.10 Lbs./Ctn.
- 40 Pc./Ctn.

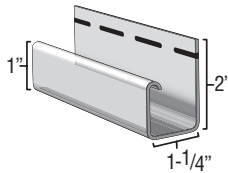

#### Standard Colors

White  
Almond  
Cream  
Gray  
Mist  
Tan

#### Dark Colors\*

Clay  
Flint  
Thistle

#### Premium Dark Colors\*

Briarwood  
Pewter  
Sagebrook  
Wedgewood

505

### Starter Strip

- Length: 12' 6"
- 42 Lbs./Ctn.
- 24 Pc./Ctn.



N/A

409

### Extended Crown Backplate

- Length: 12' 6"
- 60.90 Lbs./Ctn.
- 24 Pc./Ctn.

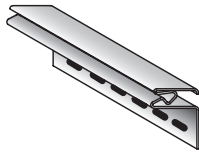

#### Standard Color

White

369

### 3-1/2" Transition Mold

- Length: 12' 6"
- 41.08 Lbs./Ctn.
- 10 Pc./Ctn.

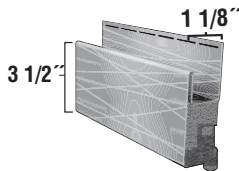

#### Standard Colors

White  
Almond  
Cream  
Gray  
Mist  
Tan

#### Dark Colors\*

Clay  
Flint  
Thistle

[Foam-backed siding options](#)



\* Upcharge applies.

# SERIES 4400 II

## DESCRIPTION & PACKAGING

284-04

### Double 4" Standard Lap Low-Gloss Finish

- Length: 12' 6"
- Thickness: .044
- 114 Lbs./Ctn.
- 24 Pc./Ctn. / 2 squares



285-04

### Double 4.5" Dutch Lap Low-Gloss Finish

- Length: 12' 1"
- Thickness: .044
- 111 Lbs./Ctn.
- 22 Pc./Ctn. / 2 squares
- 28 Sqs./Crate



## COLOR AVAILABILITY

### Standard Colors

White  
Almond  
Cream  
Gray  
Pearl  
Tan

### Dark Colors\*

Clay  
Flint  
Hazelnut  
Thistle

### Premium Colors\*

Bayou  
Briarwood  
Brownstone  
Brunswick  
Dublin  
Hampton  
Red

Iron  
Palm  
Pewter  
Sagebrook  
Shadow  
Teak  
Wedgewood

### Cedar Colors\*

Coastal Blue  
Hearthstone  
Brown  
Northern  
Oak  
Redwood

# SERIES 4400 BEADED

200

### 6-1/2" Beaded Panel Smooth, Brushed Finish

Recommended for installation with  
1WAP10 Aluminum Starter Strip.  
See page 58

- Length: 12' 4"
- Thickness: .044
- 60.09 Lbs./Ctn.
- 15 Pc./Ctn.
- 1 square
- 21 Sqs./Crate

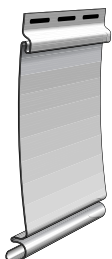

### Standard Colors

White  
Almond  
Beige  
Blue  
Cream  
Gray  
Mist  
Olive  
Pearl  
Tan

### Dark Colors\*

Clay  
Flint  
Thistle



[Vinyl siding  
profile options](#)

[Install  
horizontal  
beaded  
siding](#)



[Horizontal  
siding - last  
course in eave &  
gable](#)



\* Upcharge applies.

## DESCRIPTION & PACKAGING

## COLOR AVAILABILITY

105-04

### Double 4" Standard Lap Woodgrain Finish

- Length: 12' 6"
- Thickness: .042
- 94.67 Lbs./Ctn.
- 24 Pc./Ctn. / 2 squares
- 44 Sqs./Crate



### Standard Colors

White  
Almond  
Beige  
Blue  
Cream  
Gray  
Mist  
Olive  
Pearl  
Tan

### Dark Colors\*

Clay  
Cypress  
Flint  
Hazelnut  
Thistle

### Premium Colors\*

Briarwood  
Pewter  
Sagebrook  
Wedgewood

116-04

### Double 5" Standard Lap Woodgrain Finish

- Length: 12' 0"
- Thickness: .042
- 89.61 Lbs./Ctn.
- 20 Pc./Ctn. / 2 squares
- 40 Sqs./Crate



109-04

### Double 4" Dutch Lap Woodgrain Finish

- Length: 12' 6"
- Thickness: .042
- 94.96 Lbs./Ctn.
- 24 Pc./Ctn. / 2 squares
- 38 Sqs./Crate



119-04

### Double 5" Dutch Lap Woodgrain Finish

- Length: 12' 0"
- Thickness: .042
- 89.67 Lbs./Ctn.
- 20 Pc./Ctn. / 2 squares
- 34 Sqs./Crate



\* Upcharge applies.

## DESCRIPTION & PACKAGING

## COLOR AVAILABILITY

10002-04

### Double 5" Dutch Lap Woodgrain Finish

- Length: 12' 0"
- Thickness: .040
- 84.50 Lbs./Ctn.
- 20 Pcs./Ctn.
- 2 Sqs./Ctn.
- 34 Sqs./Crate



### Standard Colors

White  
Almond  
Blue  
Cream  
Gray  
Mist  
Olive  
Pearl  
Tan

### Dark Colors\*

Clay  
Cypress  
Flint  
Thistle

10003-04

### Double 4.5" Dutch Lap Woodgrain Finish

- Length: 12' 1"
- Thickness: .040
- 87 Lbs./Ctn.
- 22 Pcs./Ctn.
- 2 Sqs./Ctn.
- 40 Sqs./Crate



\* Upcharge applies.



## DESCRIPTION & PACKAGING

## COLOR AVAILABILITY

125-04

### Double 4" Standard Lap Woodgrain Finish

- Length: 12' 6"
- Thickness: .040
- 86.42 Lbs./Ctn.
- 24 Pcs./Ctn.
- 2 Sqs./Ctn.
- 48 Sqs./Crate



#### Standard Colors

White  
Almond  
Beige  
Blue  
Cream  
Gray  
Mist  
Olive  
Pearl  
Tan

#### Dark Colors\*

Clay  
Cypress  
Flint  
Thistle

135-04

### Double 5" Standard Lap Woodgrain Finish

- Length: 12' 0"
- Thickness: .040
- 81.84 Lbs./Ctn.
- 20 Pcs./Ctn.
- 2 Sqs./ Ctn.
- 40 Sqs./Crate



129-04

### Double 4" Dutch Lap Woodgrain Finish

- Length: 12' 6"
- Thickness: .040
- 86.68 Lbs./Ctn.
- 24 Pcs./Ctn.
- 2 Sqs./Ctn.
- 38 Sqs./Crate



139-04

### Double 5" Dutch Lap Woodgrain Finish

- Length: 12' 0"
- Thickness: .040
- 81.90 Lbs./Ctn.
- 20 Pcs./Ctn.
- 2 Sqs./Ctn.
- 34 Sqs./Crate

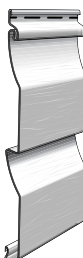

#### Standard Colors

White  
Almond  
Beige  
Blue  
Cream  
Gray  
Mist  
Olive  
Pearl  
Tan

#### Dark Color\*

Clay

\* Upcharge applies.

## DESCRIPTION & PACKAGING

## COLOR AVAILABILITY

106-04

### Double 4" Dutch Lap Woodgrain Finish

- Length: 12' 6"
- Thickness: .038
- 83.34 Lbs./Ctn.
- 24 Pcs./Ctn.
- 2 Sqs./Ctn.
- 36 Sqs./Crate



### Standard Colors

White  
Almond  
Blue  
Cream  
Gray  
Mist  
Olive  
Pearl  
Tan

### Dark Colors\*

Clay  
Cypress  
Flint

115-04

### Double 5" Dutch Lap Woodgrain Finish

- Length: 12' 0"
- Thickness: .038
- 76.30 Lbs./Ctn.
- 20 Pcs./Ctn.
- 2 Sqs./Ctn.
- 34 Sqs./Crate



110-04

### Double 4.5" Dutch Lap Woodgrain Finish

- Length: 12' 1"
- Thickness: .038
- 80.45 Lbs./Ctn.
- 22 Pcs./Ctn.
- 2 Sqs./Ctn.
- 40 Sqs./Crate

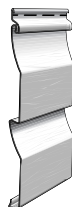

\* Upcharge applies.

## DESCRIPTION & PACKAGING

## COLOR AVAILABILITY

199

### Single Vertical 7" Board & Batten Woodgrain Finish

- Length: 10' 0"
- Thickness: .048
- 53.90 Lbs./Ctn.
- 17 Pc./Ctn.
- 1 Sq./Ctn.
- 15 Sqs./Crate



#### Standard Colors

White  
Almond  
Beige  
Blue  
Cream  
Gray  
Mist  
Olive  
Pearl  
Tan

#### Dark Colors\*

Clay  
Flint  
Hazelnut

Thistle

#### Premium Colors\*

Bayou  
Briarwood  
Brownstone  
Brunswick  
Dublin  
Hampton Red  
Palm  
Pewter  
Sagebrook  
Shadow  
Teak  
Wedgewood

# SERIES 9000

133

### Triple 3-1/3" Solid Vertical/Soffit Pebble Finish

- Length: 12' 0"
- Thickness: .044
- 119 Lbs./Ctn.
- 20 Pc./Ctn.
- 2 Sqs./Ctn.
- 24 Sqs./Crate

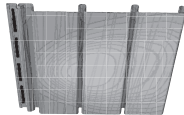

\*\*Musket Brown approved for soffit use only.

#### Standard Colors

White  
Almond  
Beige  
Cream  
Gray  
Mist  
Pearl  
Tan

#### Dark Colors\*

Clay  
Flint  
Musket Brown\*\*

#### Premium Colors\*

Bayou  
Briarwood  
Hampton Red  
Palm  
Pewter  
Sagebrook  
Shadow  
Teak  
Wedgewood

134

### Triple 3-1/3" Vented Soffit Pebble Finish

- Length: 12' 0"
- Thickness: .044
- 115 Lbs./Ctn.
- 20 Pc./Ctn.
- 2 Sqs./Ctn.
- 24 Sqs./Crate
- Net Free Air Space: 9.19 Sq. In./Sq. Ft.

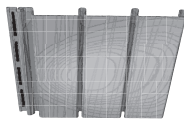

Use 5/8" installation accessories  
Approved for soffit use only.

[Installing vertical siding](#)



[Vertical siding options](#)



[Soffit options](#)



\* Upcharge applies.

# D/5 SOFFIT

## DESCRIPTION & PACKAGING

## COLOR AVAILABILITY

140

### Series 9300 Vertical/Soffit Woodgrain Finish

- Length: 12' 0"
- Thickness: .044
- 94.50 Lbs./Ctn.
- 20 Pc./Ctn.
- 2 Sqs./Ctn.
- 34 Sqs./Crate



#### Standard Colors

White  
Almond  
Beige  
Blue  
Cream  
Gray  
Mist  
Olive  
Pearl  
Tan

#### Dark Colors\*

Clay  
Flint  
Thistle  
**Premium Color\***  
Briarwood

141

### Series 9300 Perforated Soffit Woodgrain Finish

- Length: 12' 0"
- Thickness: .044
- 89.14 Lbs./Ctn.
- 20 Pc./Ctn.
- 2 Sqs./Ctn.
- 34 Sqs./Crate
- Net Free Air Space: 6.20 Sq. In./Sq. Ft.



Approved for soffit use only.

144

### Series 9200 Soffit Woodgrain Finish

- Length: 12' 0"
- Thickness: .040
- 86.64 Lbs./Ctn.
- 20 Pc./Ctn.
- 2 Sqs./Ctn.
- 34 Sqs./Crate



Approved for soffit use only.

#### Standard Colors

White  
Almond  
Beige  
Cream  
Gray  
Mist  
Olive  
Tan

#### Dark Colors\*

Clay  
Flint

Use 1/2" installation accessories

145

### Series 9200 Perforated Soffit Woodgrain Finish

- Length: 12' 0"
- Thickness: .040
- 81.78 Lbs./Ctn.
- 20 Pc./Ctn.
- 2 Sqs./Ctn.
- 34 Sqs./Crate
- Net Free Air Space: 6.20 Sq. In./Sq. Ft.



Approved for soffit use only.

Use 1/2" installation accessories

[Installing vinyl soffits](#)



\* Upcharge applies.

## DESCRIPTION & PACKAGING

## COLOR AVAILABILITY

230

### Series 9100 Solid Soffit Pebble Finish

- Length: 12' 0"
- Thickness: .038
- 80.62 Lbs./Ctn.
- 16 Pc./Ctn.
- 1.92 Sqs./Ctn.
- 36 Sqs./Crate



Approved for soffit use only.

### Standard Colors

White  
Almond  
Beige  
Blue  
Cream  
Gray  
Mist  
Pearl  
Tan

### Dark Colors\*

Black  
Clay  
Flint  
Musket Brown

231

### Series 9100 Center Vent Soffit Pebble Finish

- Length: 12' 0"
- Thickness: .038
- 79.90 Lbs./Ctn.
- 16 Pc./Ctn.
- 1.92 Sqs./Ctn.
- 36 Sqs./Crate
- Net Free Air Space: 1.956 Sq. In./Sq. Ft.

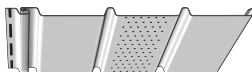

Approved for soffit use only.

### Standard Colors

White  
Almond  
Tan

### Dark Colors\*

Black  
Clay  
Musket Brown  
Thistle

232

### Series 9100 Full Vent Soffit Pebble Finish

- Length: 12' 0"
- Thickness: .038
- 78.48 Lbs./Ctn.
- 16 Pc./Ctn.
- 1.92 Sqs./Ctn.
- 36 Sqs./Crate
- Net Free Air Space: 5.867 Sq. In./Sq. Ft.

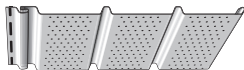

Use 1/2" installation accessories  
Approved for soffit use only.

### Standard Colors

White  
Almond  
Beige  
Blue  
Cream  
Gray  
Mist  
Pearl  
Tan

### Dark Colors\*

Black  
Clay  
Flint  
Musket Brown

\* Upcharge applies.

157

## Beaded, 7" Exposure Solid Soffit w/Pebble Finish

- Length: 12' 0"
- Thickness: .040
- 114.61 Lbs./Ctn.
- 28 Pc./Ctn.
- 2 Sqs./Ctn.
- 34 Sqs./Crate



### Standard Colors

White  
Almond  
Blue  
Pearl  
Tan

### Dark Color\*

Clay

158

## Beaded, 7" Exposure Hidden-Vent Soffit w/Pebble Finish

- Length: 12' 0"
- Thickness: .040
- 113.56 Lbs./Ctn.
- 28 Pc./Ctn.
- 2 Sqs./Ctn.
- 34 Sqs./Crate
- Net Free Air Space: 2.66 Sq. In./Sq. Ft.



Use 3/8" installation accessories  
Approved for soffit use only.

2309216

## Economy Triple 4" Solid Soffit

- Length: 12' 0"
- Thickness: .038
- 80.62 Lbs./Ctn.
- 16 Pc./Ctn.
- 1.92 Sqs./Ctn.
- 36 Sqs./Crate



Approved for soffit use only.

### Standard Color

White

2319216

## Economy Triple 4" Center Vent Soffit

- Length: 12' 0"
- Thickness: .038
- 79.90 Lbs./Ctn
- 16 Pc./Ctn.
- 1.92 Sqs./Ctn.
- 36 Sqs./Crate
- Net Free Air Space: 1.956 Sq. In./Sq. Ft.

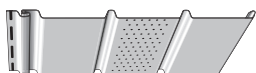

Approved for soffit use only.

\* Upcharge applies.

## DESCRIPTION & PACKAGING

## COLOR AVAILABILITY

2329216

### Economy Triple 4" Full Vent Soffit

- Length: 12' 0"
- Thickness: .038
- 78.48 Lbs./Ctn
- 16 Pc./Ctn.
- 1.92 Sqs./Ctn.
- 36 Sqs./Crate
- Net Free Air Space: 5.867 Sq. In./Sq. Ft.

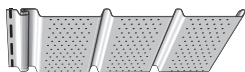

**Standard  
Color**  
White

Use 1/2" installation accessories  
Approved for soffit use only.

1449216

### Economy Double 5" Solid Soffit

- Length: 12' 0"
- Thickness: .038
- 94.50 Lbs./Ctn.
- 20 Pc./Ctn.
- 2 Sqs./Ctn.
- 34 Sqs./Crate



Approved for soffit use only.

1459216

### Economy Double 5" Full Vent Soffit

- Length: 12' 0"
- Thickness: .038
- 89.14 Lbs./Ctn.
- 20 Pc./Ctn.
- 2 Sqs./Ctn.
- 34 Sqs./Crate
- Net Free Air Space: 6.20 Sq. In./Sq. Ft.

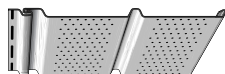

Approved for soffit use only.

[Installing porch  
ceilings/beaded  
soffit](#)



\* Upcharge applies.

# BEADED SOFFIT INSTALLATION COMPONENTS

DESCRIPTION & PACKAGING

COLOR AVAILABILITY

304

## 3/8" J-Channel Pebble Finish

- Length: 12' 6"
- 40.78 Lbs./Ctn.
- 40 Pc./Ctn.
- 44 Ctns./Crate

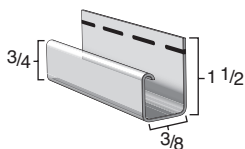

### Standard

#### Colors

White  
Almond  
Tan

### Dark Color

Clay

## SOFFIT INSTALLATION COMPONENTS

339

## 1/2" F-Trim Pebble Finish

- Length: 12' 6"
- 44.33 Lbs./Ctn.
- 40 Pc./Ctn.
- 2 Sqs./Ctn.
- 500 Ft./Ctn.
- 48 Ctns./Crate

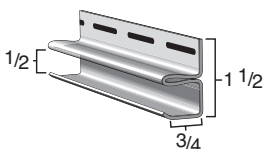

### Standard

#### Colors

White  
Almond  
Beige  
Blue  
Cream  
Gray  
Mist  
Olive  
Pearl  
Tan

### Dark Colors\*

Black  
Clay  
Flint  
Musket Brown\*  
Thistle

336

## 1/2" J-Channel Pebble Finish

- Length: 12' 6"
- 41.18 Lbs./Ctn.
- 40 Pc./Ctn.
- 500 Ft./Ctn.
- 42 Ctns./Crate

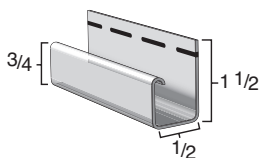

### Standard

#### Colors

White  
Almond  
Beige  
Blue  
Cream  
Gray  
Mist  
Olive  
Pearl  
Tan

### Dark Colors

Black  
Clay  
Flint  
Musket Brown\*  
Thistle

### Premium

Color\*  
Briarwood

\* Upcharge applies.



# SERIES 1000 & INSTALLATION COMPONENTS

## DESCRIPTION & PACKAGING

## COLOR AVAILABILITY

556-04

### Shingle Siding†

- Length: 54-5/8"
- Nominal Thickness: .100
- 43 Lbs./Ctn.
- 10 Pc./Ctn.
- 1/2 Sq./Ctn.
- 7 Sqs./Pallet

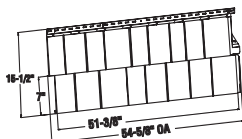

† Requires 7/8" pocket accessories.

### Standard Colors

White  
Almond  
Amber  
Bayou  
Briarwood  
Brownstone  
Brunswick  
Cinnabar  
Clay  
Cream  
Dublin  
Flint  
Gray  
Hampton Red  
Hazelnut  
Iron  
Olive  
Palm

Pearl  
Pewter  
Sagebrook  
Shadow  
Tan  
Teak  
Thistle  
Wedgewood  
**Shaded Colors\***  
Shaded Cedar  
Shaded Gray

557

### Shingle Outside Corner Post

- 3-1/2" Width
- Nominal Thickness: .100
- 15.7 Lbs./Ctn.
- 10 Pc./Ctn.
- 23.3 Ft. Exposure/Ctn.
- 18 Ctns./Pallet



559-04

### Round Cut Siding†

- Length: 51-3/4"
- Nominal Thickness: .080
- 39 Lbs./Ctn.
- 12 Pc./Ctn.
- 1/2 Sq./Ctn.
- 8 Sqs./Pallet

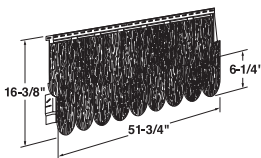

† Requires 7/8" pocket accessories.

### Standard Colors

White  
Almond  
Clay  
Cream  
Flint  
Gray  
Pearl  
Tan

560-04

### Hand-Split Siding†

- Length: 58-1/8"
- Nominal Thickness: .100
- 41 Lbs./Ctn.
- 7 Pc./Ctn.
- 1/2 Sq./Ctn.
- 8 Sqs./Pallet

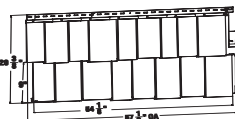

† Requires 7/8" pocket accessories.

### Standard Colors

White  
Almond  
Bayou  
Clay  
Cream  
Flint  
Gray  
Hampton Red  
Pearl  
Pewter

Sagebrook  
Shadow  
Tan  
Thistle  
Wedgewood  
**Shaded Colors\***  
Shaded Cedar  
Shaded Gray

\* Upcharge applies.

# SERIES 1000 & INSTALLATION COMPONENTS

DESCRIPTION & PACKAGING

COLOR AVAILABILITY

558

## Hand-Split Outside Corner Post

- 3-1/2" Width
- Nominal Thickness: .100
- 20 Lbs./Ctn.
- 10 Pc./Ctn.
- 30 Ft. Exposure/Ctn.
- 18 Ctns./Pallet

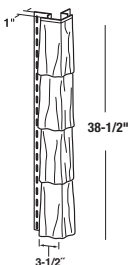

### Standard Colors

White  
Almond  
Bayou  
Clay  
Cream  
Flint  
Gray  
Hampton Red  
Pearl  
Pewter  
Sagebrook

### Shadow

Tan  
Teak  
Thistle  
Wedgewood

### Shaded Colors\*

Shaded Cedar  
Shaded Gray

570-04

## Triple 5" Shingle

- 69-1/2" Width
- Nominal Thickness: .090
- 35 Lbs./Ctn.
- 18 Ctns. @ 7 Pc./Ctn.
- .46 Sqs./Ctn.

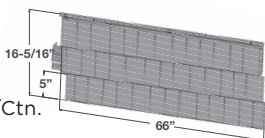

Note: 3/4" minimum vinyl siding accessories are required for installation.

### Standard Colors

White  
Almond  
Amber  
Briarwood  
Clay  
Cream  
Flint  
Gray  
Hampton Red  
Hazelnut  
Olive  
Palm  
Pearl  
Pewter  
Sagebrook  
Shadow  
Tan  
Teak  
Thistle  
Wedgewood

### Shaded Colors\*

Shaded Cedar  
Shaded Gray

571

## Triple 5" Shingle Outside Corner Post

- Length: 31"
- Nominal Thickness: .080
- 19.50 Lbs./Ctn.
- 10 Pc./Ctn.
- 31" l x 1" projection x 3-1/2" w

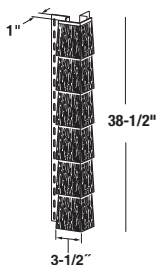

[Install cedar panels](#)



[How to replace a cedar panel](#)



[Cedar panels - last panel in eave & gable](#)

\* Upcharge applies.

# INSTALLATION COMPONENTS

## DESCRIPTION & PACKAGING

## COLOR AVAILABILITY

377

### 6" x 3/4" Fluted Outside Corner Post Pebble Finish

(A special order requirement will apply)

- Length: 20' 0"
- 41.58 Lbs./Ctn.
- 4 Pc./Ctn. / 80 Ft./Ctn.
- 8 Ctns./Crate

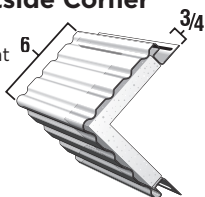

**Standard Color**  
White

407

### Traditional 5 1/2" Outside Corner Post Pebble Finish

(A special order requirement will apply)

- Length: 20' 0"
- 67 Lbs./Ctn.
- 4 Pc./Ctn. / 80 Ft./Ctn.
- 13 Ctns./Crate

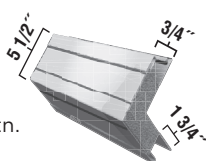

40020

### 4" x 3/4" Outside Corner Post New Woodgrain Finish

- Length: 10' 0"
- 50 Lbs./Ctn.
- 10 Pc./Ctn. / 100 Ft./Ctn.
- 10 Ctns./Crate

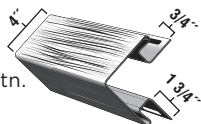

**Standard Colors**

White  
Almond  
Beige  
Blue  
Cream  
Gray  
Mist  
Olive  
Pearl  
Tan

**Dark Colors**

Clay  
Cypress  
Flint  
Hazelnut  
Thistle

**Premium Colors\***

Bayou  
Briarwood  
Brownstone  
Brunswick  
Dublin  
Hampton  
Red  
Iron  
Palm  
Pewter  
Sagebrook  
Shadow  
Teak  
Wedgewood

40041

### 4" x 3/4" Outside Corner Post New Woodgrain Finish

- Length: 10' 0"
- 25 Lbs./Ctn.
- 5 Pc./Ctn. / 50 Ft./Ctn.
- 17 Ctns./Crate

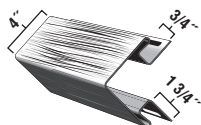

**Cedar Colors**

Costal Blue  
Hearthstone  
Brown  
Nothern Oak  
Redwood

\* Upcharge applies.

# INSTALLATION COMPONENTS

## DESCRIPTION & PACKAGING

## COLOR AVAILABILITY

40022

### 3" x 3/4" Outside Corner Post New Woodgrain Finish

- Length: 10' 0"
- 37 Lbs./Ctn.
- 10 Pc./Ctn. / 100 Ft./Ctn.
- 15 Ctns./Crate

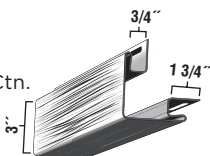

#### Standard Colors

White  
Almond  
Beige  
Blue  
Cream  
Gray  
Mist  
Olive

Pearl  
Tan  
**Dark Colors**  
Clay  
Cypress  
Flint  
Hazelnut  
Thistle

40034

### 3" x 3/4" Outside Corner Post New Woodgrain Finish

- Length: 10' 6"
- 39.44 Lbs./Ctn.
- 10 Pc./Ctn. / 105 Ft./Ctn.
- 15 Ctns./Crate

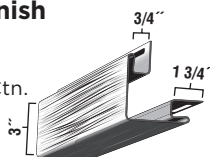

Designed for IMH

#### Standard Colors

White  
Almond  
Beige  
Cream  
Gray  
Mist

Olive  
Pearl  
Tan  
**Dark Colors**  
Clay  
Flint

40033

### 3" x 3/4" Outside Corner Post New Woodgrain Finish

- Length: 8' 6"
- 34 Lbs./Ctn.
- 10 Pc./Ctn. / 85 Ft./Ctn.
- 15 Ctns./Crate

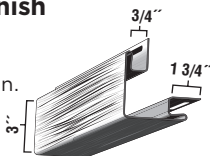

Designed for IMH

#### Standard Colors

White  
Almond  
Beige  
Blue  
Cream  
Gray  
Mist

Olive  
Pearl  
Tan  
**Dark Colors**  
Clay  
Flint

40032

### Snap-On Corner Post New Woodgrain Finish (Use with J-Channel)

- Length: 10' 0"
- 69.77 Lbs./Ctn.
- 24 Pc./Ctn. / 240 Ft./Ctn.
- 12 Ctns./Crate

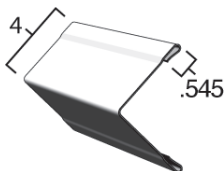

Designed for IMH  
NOTE: Replacing #354

#### Standard Colors

White  
Almond  
Beige  
Blue  
Cream  
Gray  
Mist

Olive  
Pearl  
Tan  
**Dark Colors**  
Clay  
Flint



[Flashing and installing corner posts](#)

\* Upcharge applies.

# INSTALLATION COMPONENTS

## DESCRIPTION & PACKAGING

## COLOR AVAILABILITY

376

### 2 1/4" x 5/8" Outside Corner Post Pebble Finish (Use with J-Channel)

- Length: 8' 6"
- 40 Lbs./Ctn.
- 16 Pc./Ctn. / 136 Ft./Ctn.
- 12 Ctns./Crate

Designed for IMH

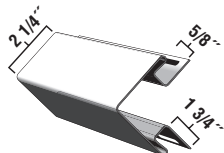

**Standard Colors**  
White  
Almond  
Beige  
Blue  
Cream  
Gray  
Mist

Olive  
Pearl  
Tan  
**Dark Colors**  
Clay  
Flint

362

### Bay Window Corner Pebble Finish

- Length: 10' 0"
- 34.72 Lbs./Ctn.
- 10 Pc./Ctn. / 100 Ft./Ctn.
- 12 Ctns./Crate

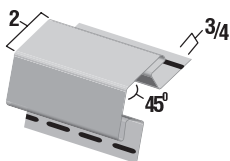

**Standard Color**  
White

364

### 3/4" Inside Corner Post Pebble Finish

- Length: 10' 0"
- 24.43 Lbs./Ctn.
- 10 Pc./Ctn. / 100 Ft./Ctn.
- 30 Ctns./Crate

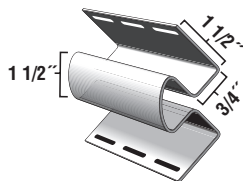

**Standard Colors**  
White  
Almond  
Beige  
Blue  
Cream  
Gray  
Mist  
Olive  
Pearl  
Tan

**Dark Colors**  
Clay  
Cypress  
Flint  
Hazelnut  
Thistle

**Premium Colors\***  
Bayou  
Briarwood  
Brownstone  
Brunswick  
Dublin  
Hampton Red  
Iron  
Palm  
Pewter  
Sagebrook  
Shadow  
Teak  
Wedgewood

40042

### 3/4" Inside Corner Post Pebble Finish

- Length: 10' 0"
- 14.66 Lbs./Ctn.
- 6 Pc./Ctn. / 60 Ft./Ctn.
- 44 Ctns./Crate

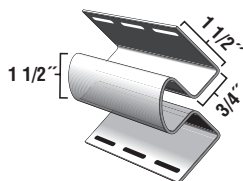

**Cedar Colors\***  
Costal Blue  
Hearthstone  
Brown  
Nothorn Oak  
Redwood

\* Upcharge applies.

# INSTALLATION COMPONENTS

## DESCRIPTION & PACKAGING

## COLOR AVAILABILITY

391

### 5" Window and Door Surround Pebble Finish

- Length: 20' 0"
- 64.73 Lbs./Ctn.
- 10 Pc./Ctn. / 200 Ft./Ctn.
- 23 Ctns./Crate

Use with 393 Starter Strips  
(A special order requirement will apply)

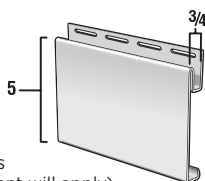

### Standard Colors

White  
Pearl  
Tan

### Dark Color

Clay

390

### 3 3/4" Window and Door Surround Pebble Finish

- Length: 20' 0"
- 57.28 Lbs./Ctn.
- 10 Pc./Ctn. / 200 Ft./Ctn.
- 32 Ctns./Crate

Use with 393 Starter Strips  
(A special order requirement will apply)

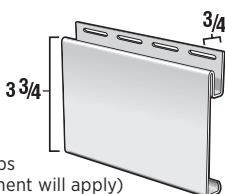

### Standard Colors

White  
Pearl  
Tan

### Dark Color

Clay

395

### 3 3/4" Window and Door Surround Pebble Finish

- Length: 12' 6"
- 37.11 Lbs./Ctn.
- 10 Pc./Ctn. / 125 Ft./Ctn.
- 32 Ctns./Crate

Use with 393 Starter Strips

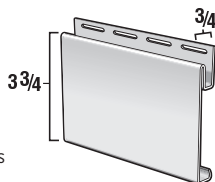

### Standard Color

White

40029

### Wide Flange J-Channel Pebble Finish

- Length: 12' 6"
- 55 Lbs./Ctn.
- 20 Pc./Ctn. / 250 Ft./Ctn.
- 24 Ctns./Crate

NOTE: Replacing #316

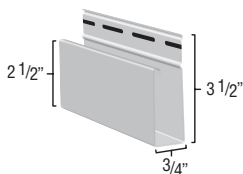

### Standard Colors

White  
Almond  
Tan

### Dark Colors

Clay

\* Upcharge applies.

# INSTALLATION COMPONENTS J-CHANNEL

## DESCRIPTION & PACKAGING

## COLOR AVAILABILITY

40024

### 7/8" J-Channel Pebble Finish

- Length: 12' 6"
- 44.18 Lbs./Ctn.
- 40 Pc./Ctn. / 500 Ft./Ctn.
- 30 Ctns./Crate

NOTE: Replacing #307

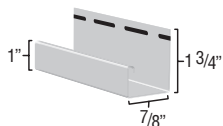

### Standard Colors

White  
Almond  
Cream  
Gray  
Olive  
Pearl  
Tan

### Dark Colors

Clay  
Flint  
Hazelnut  
Thistle

### Premium Colors\*

Bayou  
Briarwood  
Brownstone  
Brunswick  
Dublin  
Hampton Red  
Iron  
Pewter  
Sagebrook  
Shadow  
Teak  
Wedgewood

40026

### 5/8" Extended Face J-Channel Pebble Finish

- Length: 12' 6"
- 46 Lbs./Ctn.
- 40 Pc./Ctn. / 500 Ft./Ctn.
- 35 Ctns./Crate

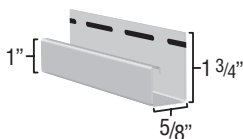

### Standard Colors

White  
Almond  
Beige  
Blue  
Cream  
Gray  
Mist  
Olive  
Pearl  
Tan

### Dark Colors

Clay  
Cypress  
Flint  
Hazelnut  
Thistle

### Premium Colors\*

Bayou  
Briarwood  
Brownstone  
Brunswick  
Dublin  
Hampton Red  
Iron  
Palm  
Pewter  
Sagebrook  
Shadow  
Teak  
Wedgewood

40045

### 7/8" J-Channel Pebble Finish

- Length: 12' 6"
- 26 Lbs./Ctn.
- 20 Pc./Ctn. / 250 Ft./Ctn.
- 31 Ctns./Crate

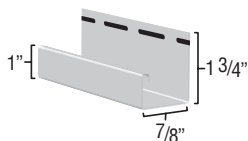

### Cedar Colors\*

Costal Blue  
Hearthstone  
Brown  
Nothorn Oak  
Redwood

[J-Channel options](#)



[Starter strip](#)



[Designer accents](#)

\* Upcharge applies.

# INSTALLATION COMPONENTS

## J-CHANNEL

### DESCRIPTION & PACKAGING

### COLOR AVAILABILITY

40043

#### 5/8" Extended Face J-Channel Pebble Finish

- Length: 12' 6"
- 23 Lbs./Ctn.
- 20 Pc./Ctn. / 250 Ft./Ctn.
- 70 Ctns./Crate

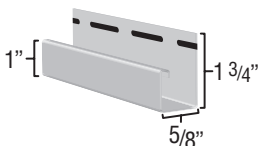

#### Cedar Colors\*

- Costal Blue
- Hearthstone
- Brown
- Nothern Oak
- Redwood

36585

#### 5/8" J-Channel Pebble Finish

- Length: 12' 6"
- 44.29 Lbs./Ctn.
- 40 Pc./Ctn. / 500 Ft./Ctn.
- 44 Ctns./Crate

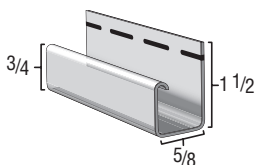

#### Standard Colors

- White
- Almond
- Beige
- Blue
- Cream
- Gray
- Mist
- Olive
- Pearl
- Tan

- Hazelnut
- Thistle
- Musket Brown\*

#### Premium Colors\*

- Briarwood
- Hampton Red
- Pewter
- Sagebrook
- Wedgewood

#### Dark Colors

- Amber
- Clay
- Cypress
- Flint

506

#### 3/4" Flexible J-Channel Matte Finish

- Length: 12' 6"
- 66 Lbs./Ctn.
- 20 Pc./Ctn. / 250 Ft./Ctn.
- 30 Ctns./Crate

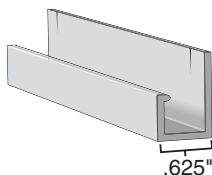

#### Standard Color

- White

40046

#### 3-1/2" Interlocking Foam Back Lineal

- Length: 12' 6"
- 65 Lbs./Ctn.
- 20 Pc./Ctn. / 250 Ft./Ctn.

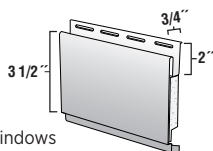

#### Standard Colors

- White
- Tan

#### Dark Color

- Clay

Note: Interlocks into vinyl windows with integrated siding receiver

\* Upcharge applies.



# INSTALLATION COMPONENTS

## DESCRIPTION & PACKAGING

## COLOR AVAILABILITY

40047

### 5" Interlocking Foam Back Lineal

- Length: 12' 6"
- 58 Lbs./Ctn.
- 15 Pc./Ctn. / 187.5 Ft./Ctn.

Note: Interlocks into vinyl windows with integrated siding receiver

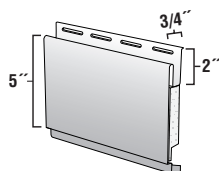

**Standard Colors**  
White  
Tan  
**Dark Color**  
Clay

40030

### Window/Door Trim Pebble Finish

- Length: 12' 6"
- 82.88 Lbs./Ctn.
- 40 Pc./Ctn. / 500 Ft./Ctn.
- 20 Ctns./Crate

Designed for IMH  
NOTE: Replacing #347

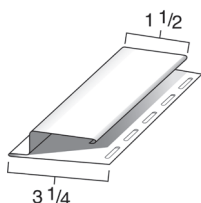

**Standard Colors**  
White  
Almond  
Beige  
Blue  
Cream  
Gray  
Mist  
Olive  
Pearl  
Tan  
**Dark Colors**  
Clay  
Flint

40031

### Window/Door Trim Pebble Finish

- Length: 8' 0"
- 57.21 Lbs./Ctn.
- 40 Pc./Ctn. / 320 Ft./Ctn.
- 17 Ctns./Crate

Designed for IMH  
NOTE: Replacing #347

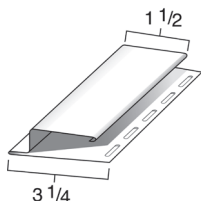

**Standard Color**  
White

365

### Wide Crown Mold Pebble Finish

- Length: 12' 6"
- 33.71 Lbs./Ctn.
- 24 Pc./Ctn. / 300 Ft./Ctn.
- 40 Ctns./Crate

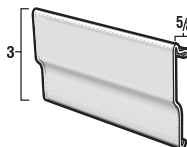

**Standard Colors**  
White  
Almond  
Beige  
Blue  
Gray  
**Dark Colors**  
Mist  
Olive  
Pearl  
Tan  
Clay  
Flint



[Install lineals around new & remodeled windows](#)

[Install lineals as band boards and gables](#)



\* Upcharge applies.

# INSTALLATION COMPONENTS J-CHANNEL

DESCRIPTION & PACKAGING

COLOR AVAILABILITY

366

## Universal Back Plate Pebble Finish

- Length: 12' 6"
- 34.79 Lbs./Ctn.
- 24 Pc./Ctn. / 300 Ft./Ctn.
- 70 Ctns./Crate



**Standard Color**  
White

367

## Frieze Back Plate Pebble Finish

- Length: 12' 6"
- 44.51 Lbs./Ctn.
- 24 Pc./Ctn. / 300 Ft./Ctn.
- 44 Ctns./Crate



328

## One Piece Wide Crown Mold Pebble Finish

- Length: 12' 6"
- 46.46 Lbs./Ctn.
- 24 Pc./Ctn. / 300 Ft./Ctn.
- 20 Ctns./Crate

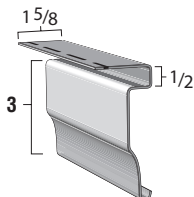

**Standard Colors**  
White  
Almond  
Beige  
Blue  
Cream  
Gray  
Mist  
Olive  
Pearl  
Tan

**Dark Colors**  
Clay  
Flint

327

## Narrow Cove Mold Pebble Finish

- Length: 12' 6"
- 35.55 Lbs./Ctn.
- 24 Pc./Ctn. / 300 Ft./Ctn.
- 24 Ctns./Crate

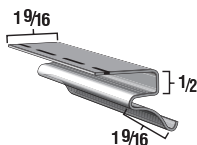

Designed for IMH  
NOTE: Replacing #344

\* Upcharge applies.

# INSTALLATION COMPONENTS

## DESCRIPTION & PACKAGING

## COLOR AVAILABILITY

396

### Dual Finish Trim Pebble Finish

- Length: 12' 6"
- 41.16 Lbs./Ctn.
- 24 Pc./Ctn. / 300 Ft./Ctn.
- 41 Ctns./Crate

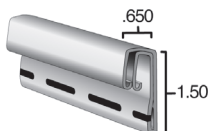

### Standard Colors

White  
Almond  
Beige  
Gray  
Mist  
Pearl  
Tan

### Dark Colors

Clay  
Flint

40028

### Finish Trim Pebble Finish

- Length: 12' 6"
- 46 Lbs./Ctn.
- 40 Pc./Ctn. / 500 Ft./Ctn.
- 70 Ctns./Crate

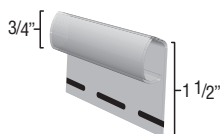

### Standard Colors

White  
Almond  
Beige  
Blue  
Cream  
Gray  
Mist  
Olive  
Pearl  
Tan

### Dark Colors

Clay  
Cypress  
Flint  
Hazelnut  
Thistle

### Premium Colors\*

Bayou  
Briarwood  
Brownstone  
Brunswick  
Dublin  
Hampton Red  
Iron  
Palm  
Pewter  
Sagebrook  
Shadow  
Teak  
Wedgewood

40044

### Finish Trim Pebble Finish

- Length: 12' 6"
- 23 Lbs./Ctn.
- 20 Pc./Ctn. / 250 Ft./Ctn.
- 110 Ctns./Crate

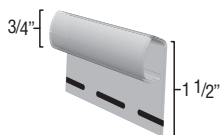

### Cedar Colors\*

Costal Blue  
Hearthstone  
Brown  
Nothern Oak  
Redwood

CDSS 00

### Universal Aluminum Cedar Starter

- Length: 10' 0"
- 32 Lbs./Ctn.
- 50 Pc./Ctn.
- Nominal Thickness: .019

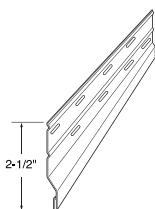

Mill Finish

\* Upcharge applies.

# PLY GEM SHUTTERS | ACCENTS MOUNTING BLOCKS & UTILITY VENTS

DESCRIPTION & PACKAGING

COLOR AVAILABILITY

## UNIBLOCK

### J-Block Square Mounting Block

Mounting Surface:

- 5" x 6"

Trim Ring Dimensions:

- 7-1/4" x 8-1/8"

J-Channel I.D.:

- 1/2" adjusts to 1-1/4"

Knockouts:

- Round: 4" Diameter
- Rectangle: 2-3/8" x 3-3/4"
- 10 Pcs./Ctn.
- 6 Lbs./Ctn.

Uses: Light Fixtures, Electrical Receptacles, Water Faucets

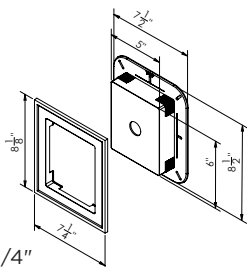

## UNIBLOCKSC

### J-Block® Square Mounting Block Scroll 4" Knockout

Mounting Surface:

- 5" x 6"

Trim Ring Dimensions:

- 7-1/4" x 8-1/8"

J-Channel I.D.:

- 1/2" adjusts to 1-1/4"

Knockouts:

- Round: 4" Diameter
- Rectangle: 2-3/8" x 3-3/4"
- 10 Pcs./Ctn.
- 6 Lbs./Ctn.

Uses: Light Fixtures, Electrical Receptacles, Water Faucets

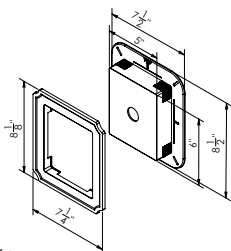

[Install mounting  
blocks and fixture  
vents](#)

# PLY GEM SHUTTERS | ACCENTS MOUNTING BLOCKS & UTILITY VENTS

DESCRIPTION & PACKAGING

COLOR AVAILABILITY

## MBLOCK

### Mini J-Block Mounting Block

Mounting Surface:

- 6" x 4-3/8"

Flange Dimensions:

- 6 7/8" x 5-1/4"

J-Channel I.D.:

- 3/4" adjusts to 1-1/4"

Knockouts:

- Round: 1-1/8" Diameter
- Rectangle: 2-3/8" x 3-3/4"

• 10 Pcs./Ctn.

• 3 Lbs./Ctn.

Uses: Doorbell, Electrical Outlet

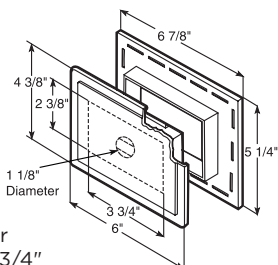

For color availability, refer to list on page 64.

## MBLOCKR

### Split Recessed J-Block Mounting Block

Mounting Surface:

- 3-5/8" x 5-1/4"

Trim Ring Dimensions:

- 5-5/8" x 7-3/8"

J-Channel I.D.:

- 1/2" adjusts to 1-1/4"

Knockouts:

- Rectangle: 2-1/4" x 3-7/8"

• 10 Pcs./Ctn.

• 3.4 Lbs./Ctn.

Uses: Faucets, Electrical Outlet

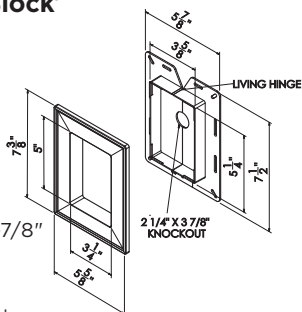

# PLY GEM SHUTTERS | ACCENTS MOUNTING BLOCKS & UTILITY VENTS

DESCRIPTION & PACKAGING

COLOR AVAILABILITY

## EBLOCK

### UL Electrical Block\*

Mounting Surface:

- 5" x 6"

Projection:

- 2-1/8"

Trim Ring Dimensions:

- 7-1/8" x 8-1/8"

J-Channel I.D.:

- 1/2" adjusts to 1-1/4"

- 1 Pc./Ctn.

- 1 Lbs./Ctn.

\* Includes UL approved black electrical box

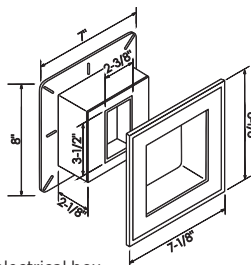

For color availability, refer to list on page 64.

## JMBLOCK

### Large J-Block® Mounting Block

Mounting Surface:

- 6" x 10-1/8"

Trim Ring Dimensions:

- 8-3/8" x 12-1/2"

J-Channel I.D.:

- 1/2" adjusts to 1-1/4"

- 5 Pcs./Ctn.

- 4 Lbs./Ctn.

Uses: Light Fixtures, Mailbox,

House Numbers

Can be used with insulated siding.

Does not include electrical box.

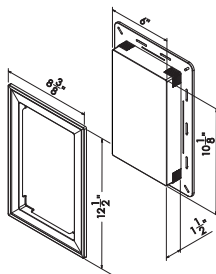

## JMBLOCKSC

### Large J-Block® Mounting Block with Scroll Cut Square

Mounting Surface:

- 6" x 10-1/8"

Trim Ring Dimensions:

- 8-3/8" x 12-1/2"

J-Channel I.D.:

- 1/2" adjusts to 1-1/4"

- 5 Pcs./Ctn.

- 4 Lbs./Ctn.

Uses: Light Fixtures, Mailbox,

House Numbers

Can be used with insulated siding.

Does not include electrical box.

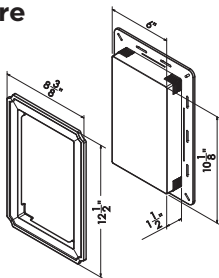

# PLY GEM SHUTTERS | ACCENTS MOUNTING BLOCKS & UTILITY VENTS

DESCRIPTION & PACKAGING

COLOR AVAILABILITY

## JMEBLOCK

### Large J-Block® Mounting Block with UL Electrical Box\*

Mounting Surface:

- 6" x 10-1/8"

Trim Ring Dimensions:

- 8-3/8" x 12-1/2"
- Adjusts 1/2" - 1-1/4"

- 4 Pcs./Ctn.
- 4.5 Lbs./Ctn.

\* Includes UL approved black electrical box

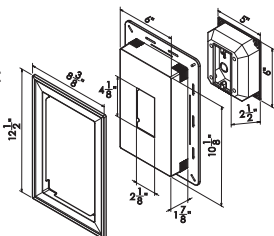

For color availability, refer to list on page 64.

## JMEBLOCKSC

### Large J-Block® Mounting Block with UL Electrical Box Scroll Cut\*

Mounting Surface:

- 6" x 10-1/8"

Trim Ring Dimensions:

- 8-3/8" x 12-1/2"
- Adjusts 1/2" - 1-1/4"

- 4 Pcs./Ctn.
- 4.5 Lbs./Ctn.

\* Includes UL approved black electrical box

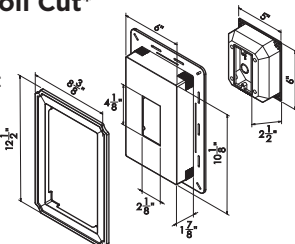

## JMEOBLOCK

### Large J-Block® Mounting Block with UL Electrical Box Offset\*

Mounting Surface:

- 6" x 10-1/8"

Trim Ring Dimensions:

- 8-3/8" x 12-1/2"
- Adjusts 1/2" - 1-1/4"

- 4 Pcs./Ctn.
- 4.5 Lbs./Ctn.

\* Includes UL approved black electrical box

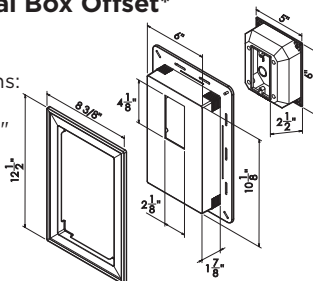

# PLY GEM SHUTTERS | ACCENTS MOUNTING BLOCKS & UTILITY VENTS

DESCRIPTION & PACKAGING

COLOR AVAILABILITY

## JMEOBLOCKSC

### Large J-Block® Mounting Block with UL Electrical Box Offset Scroll\*

Mounting Surface:

- 6" x 10-1/8"

Trim Ring Dimensions:

- 8-3/8" x 12-1/2"

J-Channel I.D.:

- 1/2" adjusts to 1-1/4"

- 4 Pcs./Ctn.

- 4.5 Lbs./Ctn.

\* Includes UL approved black electrical box

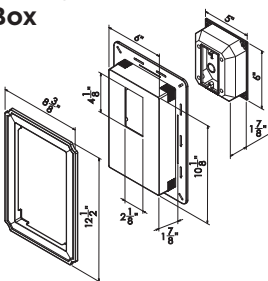

## UNIBLOCKXL

### Large J-Block® Mounting Block

Mounting Surface:

- 9" x 16"

Trim Ring Dimensions:

- 11-3/4" x 18-3/4"

J-Channel I.D.:

- 1/2" adjusts to 1-1/4"

Knockouts:

- Round: 4" Diameter

- Rectangle: 2-3/8" x 3-3/4"

- 4 Pcs./Ctn.

- 5 Lbs./Ctn.

Uses: Light Fixtures, Mailbox, House Numbers

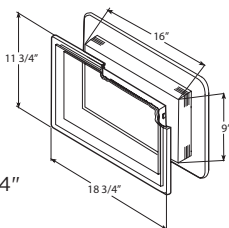

## METERLG

### Jumbo Meter Base

#### J-Block®

Mounting Surface:

- 20" x 24"

Trim Ring Dimensions:

- 21-1/2" x 24-1/2"

J-Channel I.D.:

- 1/2" adjusts to 1-1/4"

- 1 Pcs./Ctn.

- 4 Lbs./Ctn.

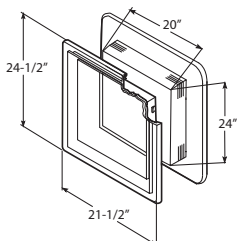



# PLY GEM SHUTTERS | ACCENTS MOUNTING BLOCKS & UTILITY VENTS

DESCRIPTION & PACKAGING

COLOR AVAILABILITY

## METER

### Meter Base J-Block®

Mounting Surface:

- 16-1/2" x 15-1/2"

Flange Dimensions:

- 18-1/2" x 16-3/4"

J-Channel I.D.:

- 1-1/4"
- 5 Pcs./Ctn.
- 10 Lbs./Ctn.

Uses: Hose Rack, Electric Meter Base

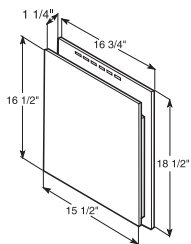

For color availability, refer to list on page 64.

# PLY GEM SHUTTERS | ACCENTS MOUNTING BLOCKS & UTILITY VENTS

DESCRIPTION & PACKAGING

COLOR AVAILABILITY

EZBLK040

## Square Surface Mount (Double 4" or Double 5")

Surface Dimensions:

- 6-3/4" x 6-3/4"

Projections: 3/4"

Knockouts:

- Round: 1" Diameter
- Rectangle: 2-3/8" x 3-3/4"

- 10 Pcs./Ctn.
- 4 Lbs./Ctn.

Uses: Light Fixtures, Electrical Receptacles,  
Water Faucets

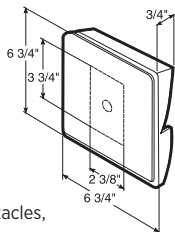

For color availability, refer  
to list on page 64.

EZBLK070

## Square Surface Mount (Dutch Lap)

Surface Dimensions:

- 6-3/4" x 6-3/4"

Projections: 3/4"

Knockouts:

- Round: 1" Diameter
- Rectangle: 2-3/8" x 3-3/4"

- 10 Pcs./Ctn.
- 4 Lbs./Ctn.

Uses: Light Fixtures, Electrical Outlets, Water Faucets

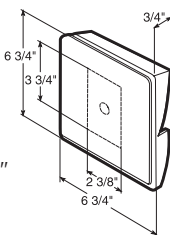

EZBLK080

## Octagon Surface Mount (Double 4" or Double 5")

Surface Dimensions:

- 6-3/4" x 6-3/4"

Projections: 3/4"

Knockouts:

- Round: 1" Diameter
- Rectangle: 2-3/8" x 3-3/4"

- 10 Pcs./Ctn.
- 3.34 Lbs./Ctn.

Uses: Light Fixtures, Electrical Outlets,  
Water Faucets

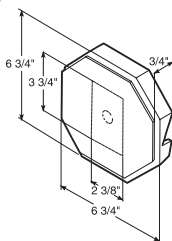

# PLY GEM SHUTTERS | ACCENTS MOUNTING BLOCKS & UTILITY VENTS

DESCRIPTION & PACKAGING

COLOR AVAILABILITY

## DRYERHOOD

### 4" Hooded Exhaust Vent System

Flange Dimensions:

- 6-5/8" x 6-5/8"

Hood Dimensions:

- 6-7/8" x 6-7/8"

J-Channel I.D.:

- 3/4" adjusts to 1-1/4"

• Tube Length: 10"

• Tube Diameter: 4"

• 1 System/Ctn.

• 1 Lb./Ctn.

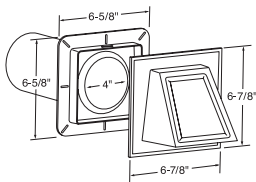

For color availability, refer to list on page 64.

## DRYERHOOD6

### 6" Hooded Exhaust Vent System

Flange Dimensions:

- 9" x 9"

Hood Dimensions:

- 8-1/2" x 8-1/2"

J-Channel I.D.:

- 3/4" adjusts to 1-1/4"

• Tube Length: 10"

• Tube Diameter: 6"

• 1 System/Ctn.

• 1 Lb./Ctn.

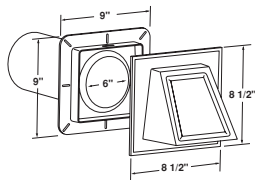

### EXVENT

For color availability, refer to list on page 64.

#### Louvered Exhaust Vent

Flange Dimensions:

- 7-1/2" x 8-1/2"

Cap Dimensions:

- 7" x 7"

J-Channel I.D.:

- 3/4" adjusts to 1-1/4"

Net Free Area:

- 12.57 Sq. In.
- Tube Length: 10"
- Tube Diameter: 4"
- 1 System/Ctn.
- 1 Lb./Ctn.

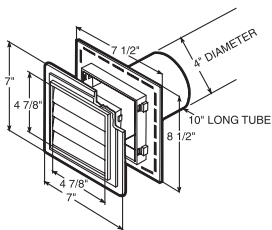

### EXVENT6

#### 6" Louvered Exhaust Vent

Flange Dimensions:

- 9-1/2" x 10-3/8"

Cap Dimensions:

- 9" x 9"

J-Channel I.D.:

- 3/4" adjusts to 1-1/4"

Net Free Area:

- 17.6 Sq. In.
- Tube Length: 10"
- Tube Diameter: 6"
- 1 System/Ctn.
- 1.2 Lb./Ctn.

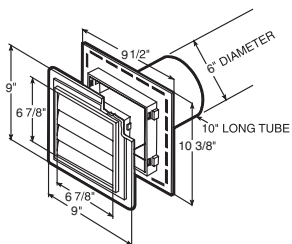

# PLY GEM SHUTTERS | ACCENTS MOUNTING BLOCKS & UTILITY VENTS

## DESCRIPTION & PACKAGING

## COLOR AVAILABILITY

### INTVENT

For color availability, refer to list on page 64.

#### Intake/Exhaust Vent

Flange Dimensions:

- 7-1/2" x 7-1/2"

Cap Dimensions:

- 8" x 8"

J-Channel I.D.:

- 1/2" adjusts to 1-1/4"

Net Free Area:

- 12.3 Sq. In.
- Tube Length: 10"
- Tube Diameter: 4"

• 1 Pc./Ctn.

• 1 Lb./Ctn.

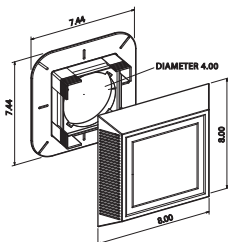

**FIRE HAZARD:** NEVER use exhaust vent with screen for dryer ventilation. Flammable lint build-up on screen can cause a fire. Always use a vent that is specifically designed for dryer applications.

### INTVENT6

#### 6" Intake/Exhaust Vent

Flange Dimensions:

- 9-1/2" x 9-1/2"

Cap Dimensions:

- 10" x 10"

J-Channel I.D.:

- 1/2" adjusts to 1-1/4"

Net Free Area:

- 14.75 Sq. In.
- Tube Length: 10"
- Tube Diameter: 6"

• 1 Pc./Ctn.

• 1.2 Lb./Ctn.

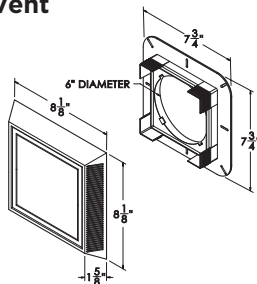

**FIRE HAZARD:** NEVER use exhaust vent with screen for dryer ventilation. Flammable lint build-up on screen can cause a fire. Always use a vent that is specifically designed for dryer applications.

### FVENT

#### Foundation Vent

Flange Dimensions:

- 18-1/8" x 9-1/2"

Cap Dimensions:

- 16-7/8" x 8-3/4"

J-Channel I.D.:

- 3/4" adjusts to 1-1/4"

Net Free Area:

- 48 Sq. In.
- 10 Pc./Ctn.
- 11.94 Lb./Ctn.

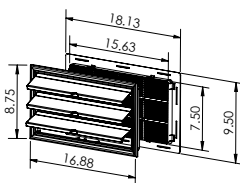

# PLY GEM SHUTTERS | ACCENTS MOUNTING BLOCKS & UTILITY VENTS

DESCRIPTION & PACKAGING

COLOR AVAILABILITY

MHBLK1PW

Paintable White

## Rectangular Block

Surface Dimensions:

- 7-3/4" x 7-3/4"

Rectangular Cutout:

- 2-1/2" x 3-3/4"

- 53 Pc./Ctn.

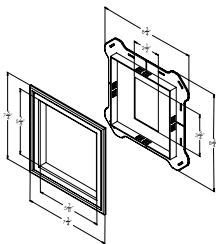

MHBLK2 PW

## Circle Cutout Block

Surface Dimensions:

- 7-3/4" x 7-3/4"

Circle Cutout:

- 4-1/8"

- 53 Pc./Ctn.

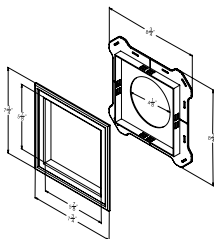

MHMBLOCKR PW

## Split Recessed Block

Surface Dimensions:

- 5-1/4" x 7"

Flange Dimensions:

- 5-7/8" x 7-1/2"

J-Channel I.D.:

- 3/4 adjusts to 1-1/4"

Scored Knockout:

- 2-1/4" x 3-7/8" rectangle

- 4 Lbs./Ctn.

- 84 Pc./Ctn.

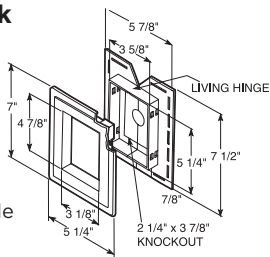

# PLY GEM SHUTTERS | ACCENTS MOUNTING BLOCKS & UTILITY VENTS

DESCRIPTION & PACKAGING

COLOR AVAILABILITY

MHMVENT PW

Paintable White

## Microwave Vent (with tube)

Surface Dimensions:

- 12-3/8" x 5-5/8"
- Tube Included
- 14 Pc./Ctn.

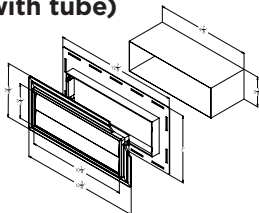

MHDVENT PW

## Dryer Vent

Surface Dimensions:

- 6-1/8" x 6-1/8"
- 56 Pc./Ctn.

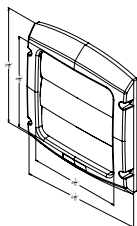

MCDVENT2 PW

## Dryer Vent - 2 Piece

Surface Dimensions:

- 6-1/8" x 6-1/8"
- 40 Pc./Ctn.

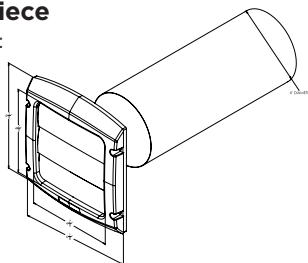

### RDGV18

#### 18" Round Gable Vent

Siding Receiver:

- 3/4" - 1-1/4"  
in 1/8" increments

Net Free Area:

- 48.36 Sq. In.
- 1 Pc./Ctn.
- 2.3 Lbs./Ctn.

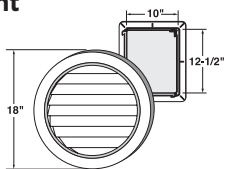

For color availability, refer to list on page 64.

### RDGV

#### 22" Round Gable Vent

Siding Receiver:

- 3/4" - 1-1/4"  
in 1/8" increments

Net Free Area:

- 48.37 Sq. In.
- 1 Pc./Ctn.
- 4.1 Lbs./Ctn.

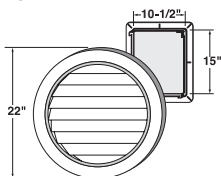

### RDGV36

#### 36" Round Gable Vent

Siding Receiver:

- 3/4" - 1-1/4"  
in 1/8" increments

Net Free Area:

- 277.1 Sq. In.
- 1 Pc./Ctn.
- 8 Lbs./Ctn.

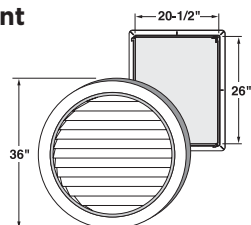

[Install gable vents](#)



# PLY GEM SHUTTERS | ACCENTS MOUNTING BLOCKS & UTILITY VENTS

DESCRIPTION & PACKAGING

COLOR AVAILABILITY

## OCTGV18

### 18" Octagon Gable Vent

Siding Receiver:

- 3/4" - 1-1/4"  
in 1/8" increments

Net Free Area:

- 49.72 Sq. In.
- 1 Pc./Ctn.
- 2.4 Lbs./Ctn.

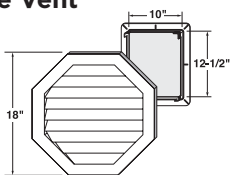

For color availability, refer to list on page 64.

## OCTGV

### 22" Octagonal Gable Vent

Siding Receiver:

- 3/4" - 1-1/4"  
in 1/8" increments

Net Free Area:

- 49.5 Sq. In.
- 1 Pc./Ctn.
- 5 Lbs./Ctn.

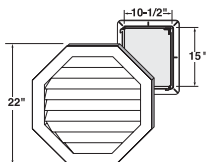

## HRDGV

### 22" Half Round Gable Vent

Siding Receiver:

- 3/4" - 1-1/4"  
in 1/8" increments

Net Free Area:

- 80.46 Sq. In.
- 1 Pc./Ctn.
- 8 Lbs./Ctn.

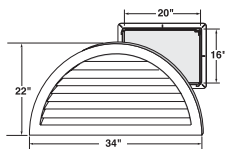

# PLY GEM SHUTTERS | ACCENTS MOUNTING BLOCKS & UTILITY VENTS

DESCRIPTION & PACKAGING

COLOR AVAILABILITY

RDTOPGV14

## 14" x 22" Round Top Gable Vent

Siding Receiver:

- 3/4" - 1-1/4"  
in 1/8" increments

Net Free Area:

- 53.17 Sq. In.
- 1 Pc./Ctn.
- 2.7 Lbs./Ctn.

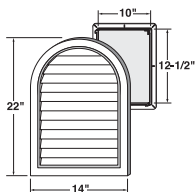

For color availability, refer to list on page 64.

RDTOPGV24

## 24" x 34" Round Top Gable Vent

Siding Receiver:

- 3/4" - 1-1/4"  
in 1/8" increments

Net Free Area:

- 191 Sq. In.
- 1 Pc./Ctn.
- 6 Lbs./Ctn.

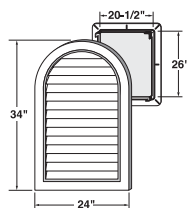

# PLY GEM SHUTTERS | ACCENTS MOUNTING BLOCKS & UTILITY VENTS

DESCRIPTION & PACKAGING

COLOR AVAILABILITY

SQGV1414

For color availability, refer to list on page 64.

## 14" Square Gable Vent

Siding Receiver:

- 3/4" - 1-1/4"  
in 1/8" increments

Net Free Area:

- 33.59 Sq. In.
- 1 Pc./Ctn.
- 2.3 Lbs./Ctn.

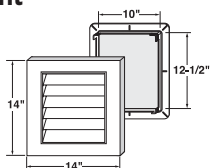

RECTGV

## 14" x 20" Rectangular Gable Vent

Siding Receiver:

- 3/4" - 1-1/4"  
in 1/8" increments

Net Free Area:

- 23.29 Sq. In.
- 1 Pc./Ctn.
- 3.83 Lbs./Ctn.

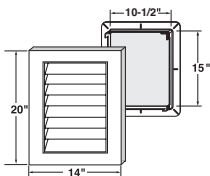

RECTGV1824

## 18" x 24" Rectangular Gable Vent

Siding Receiver:

- 3/4" - 1-1/4"  
in 1/8" increments

Net Free Area:

- 92.88 Sq. In.
- 1 Pc./Ctn.
- 5.68 Lbs./Ctn.

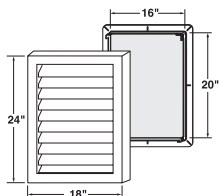

RECTGV2430

## 24" x 30" Rectangular Gable Vent

Siding Receiver:

- 3/4" - 1-1/4"  
in 1/8" increments

Net Free Area:

- 181.2 Sq. In.
- 1 Pc./Ctn.
- 9 Lbs./Ctn.

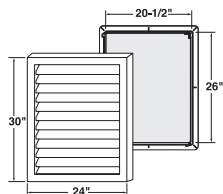

# PLY GEM SHUTTERS

## STANDARD 12" & 15" RAISED PANEL

### DESCRIPTION & PACKAGING

### COLOR AVAILABILITY

VINRP12

#### Standard Raised Panel Shutters

- 12" Wide (Nominal)
- High Density Copolymer
- Baked-on Acrylic Finish
- 1 Pair/Ctn.

| Product Code | Length | Lbs./Ctn.    |
|--------------|--------|--------------|
| VINRP1227    | 27"    | 6 Lbs./Ctn.  |
| VINRP1231    | 31"    | 7 Lbs./Ctn.  |
| VINRP1235    | 35"    | 8 Lbs./Ctn.  |
| VINRP1239    | 39"    | 8 Lbs./Ctn.  |
| VINRP1243    | 43"    | 9 Lbs./Ctn.  |
| VINRP1247    | 47"    | 10 Lbs./Ctn. |
| VINRP1251    | 51"    | 11 Lbs./Ctn. |
| VINRP1255    | 55"    | 12 Lbs./Ctn. |
| VINRP1259    | 59"    | 12 Lbs./Ctn. |
| VINRP1263    | 63"    | 13 Lbs./Ctn. |
| VINRP1267    | 67"    | 13 Lbs./Ctn. |
| VINRP1271    | 71"    | 15 Lbs./Ctn. |

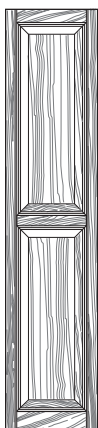

Regular Style

- 11 White
- 33 Black
- 99 Blackwatch Green
- 41 Blue
- 59 Brown
- BLU Coastal Blue
- IJ Dark Berry
- 95 Dark Navy
- 56 Dark Spruce
- 55 Green
- 16 Grey
- 52 Pebblestone Clay
- PE Peppercorn
- 38 Red
- CRM Sand Dollar
- 93 Spanish Moss
- SL Terra Brown
- SK Vineyard Red
- 58 Winestone

#### SHERWIN-WILLIAMS®

- EGF Evergreen Fog, SW 9130
- GAF Gale Force, SW 7605
- URB Urbane Bronze, SW 7048

VINRP15

#### Standard Raised Panel Shutters

- 15" Wide (Nominal)
- High Density Copolymer
- Baked-on Acrylic Finish
- 1 Pair/Ctn.

| Product Code | Length | Lbs./Ctn.    |
|--------------|--------|--------------|
| VINRP1531    | 31"    | 6 Lbs./Ctn.  |
| VINRP1535    | 35"    | 7 Lbs./Ctn.  |
| VINRP1539    | 39"    | 8 Lbs./Ctn.  |
| VINRP1543    | 43"    | 8 Lbs./Ctn.  |
| VINRP1547    | 47"    | 9 Lbs./Ctn.  |
| VINRP1551    | 51"    | 10 Lbs./Ctn. |
| VINRP1555    | 55"    | 10 Lbs./Ctn. |
| VINRP1559    | 59"    | 11 Lbs./Ctn. |
| VINRP1563    | 63"    | 12 Lbs./Ctn. |
| VINRP1567    | 67"    | 13 Lbs./Ctn. |
| VINRP1567C   | 67"    | 13 Lbs./Ctn. |
| VINRP1571    | 71"    | 13 Lbs./Ctn. |
| VINRP1575    | 75"    | 14 Lbs./Ctn. |
| VINRP1581    | 81"    | 15 Lbs./Ctn. |

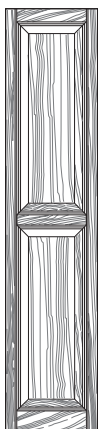

Regular Style



Cottage Style  
(67" Length only)



[Installing Shutters](#)

Notes: All shutter dimensions are nominal. All louvered and raised panel shutter cartons include 3" painted steel mounting screws and shutter plugs.

Sherwin-Williams® is a registered trademark of SWIMC LLC.

# PLY GEM SHUTTERS STANDARD 12" & 15" LOUVERED

## DESCRIPTION & PACKAGING

## COLOR AVAILABILITY

VINLV12

### Standard Open Louvered Shutters

- 12" Wide (Nominal)
- High Density Copolymer
- Baked-on Acrylic Finish
- 1 Pair/Ctn.

| Product Code | Length | Lbs./Ctn.    |
|--------------|--------|--------------|
| VINLV1255    | 55"    | 12 Lbs./Ctn. |
| VINLV1259    | 59"    | 12 Lbs./Ctn. |



Regular Style

- 11 White
- 33 Black
- 99 Blackwatch Green
- 41 Blue
- 59 Brown
- BLU Coastal Blue
- IJ Dark Berry
- 95 Dark Navy
- 56 Dark Spruce
- 55 Green
- 16 Grey
- 52 Pebblestone Clay
- PE Peppercorn
- 38 Red
- CRM Sand Dollar
- 93 Spanish Moss
- SL Terra Brown
- SK Vineyard Red
- 58 Winestone

### SHERWIN-WILLIAMS®

- EGF Evergreen Fog,  
SW 9130
- GAF Gale Force,  
SW 7605
- URB Urbane Bronze,  
SW 7048

VINLV15

### Standard Open Louvered Shutters

- 15" Wide (Nominal)
- High Density Copolymer
- Baked-on Acrylic Finish
- 1 Pair/Ctn.

| Product Code | Length | Lbs./Ctn.    |
|--------------|--------|--------------|
| VINLV1525    | 25"    | 5 Lbs./Ctn.  |
| VINLV1531    | 31"    | 6 Lbs./Ctn.  |
| VINLV1535    | 35"    | 7 Lbs./Ctn.  |
| VINLV1539    | 39"    | 7 Lbs./Ctn.  |
| VINLV1543    | 43"    | 8 Lbs./Ctn.  |
| VINLV1547    | 47"    | 8 Lbs./Ctn.  |
| VINLV1551    | 51"    | 9 Lbs./Ctn.  |
| VINLV1555    | 55"    | 11 Lbs./Ctn. |
| VINLV1559    | 59"    | 11 Lbs./Ctn. |
| VINLV1563    | 63"    | 11 Lbs./Ctn. |
| VINLV1567    | 67"    | 12 Lbs./Ctn. |
| VINLV1567C   | 67"    | 12 Lbs./Ctn. |
| VINLV1571    | 71"    | 12 Lbs./Ctn. |
| VINLV1575    | 75"    | 14 Lbs./Ctn. |
| VINLV1581    | 81"    | 14 Lbs./Ctn. |



Regular Style



Cottage Style  
(67" Length only)

Notes: All shutter dimensions are nominal. All louvered and raised panel shutter cartons include 3" painted steel mounting screws and shutter plugs.

Sherwin-Williams® is a registered trademark of SWIMC LLC.

# PLY GEM SHUTTERS

## STANDARD 11" & 12" BOARD+BATTEN

### DESCRIPTION & PACKAGING

### COLOR AVAILABILITY

#### VIN3C11 & VIN3O12

#### Standard Board+Batten 3-Board Shutters

- 11" -12" Wide (Nominal)
- High Density Copolymer
- Baked-on Acrylic Finish
- 1 Pair/Ctn.

#### CLOSED

| Product Code | Length  | Lbs./Ctn.     |
|--------------|---------|---------------|
| VIN3C1131    | 11"x31" | 4.5 Lbs./Ctn. |
| VIN3C1135    | 11"x35" | 5 Lbs./Ctn.   |
| VIN3C1139    | 11"x39" | 5 Lbs./Ctn.   |
| VIN3C1143    | 11"x43" | 5.5 Lbs./Ctn. |
| VIN3C1147    | 11"x47" | 6 Lbs./Ctn.   |
| VIN3C1151    | 11"x51" | 6 Lbs./Ctn.   |
| VIN3C1155    | 11"x55" | 7 Lbs./Ctn.   |
| VIN3C1159    | 11"x59" | 7.5 Lbs./Ctn. |
| VIN3C1163    | 11"x63" | 8 Lbs./Ctn.   |
| VIN3C1167    | 11"x67" | 8.5 Lbs./Ctn. |
| VIN3C1171    | 11"x71" | 9 Lbs./Ctn.   |
| VIN3C1175    | 11"x75" | 9 Lbs./Ctn.   |
| VIN3C1181    | 11"x81" | 10 Lbs./Ctn.  |

#### OPEN

| Product Code | Length  | Lbs./Ctn.     |
|--------------|---------|---------------|
| VIN3O1231    | 12"x31" | 4.5 Lbs./Ctn. |
| VIN3O1235    | 12"x35" | 5 Lbs./Ctn.   |
| VIN3O1239    | 12"x39" | 5 Lbs./Ctn.   |
| VIN3O1243    | 12"x43" | 6 Lbs./Ctn.   |
| VIN3O1247    | 12"x47" | 6 Lbs./Ctn.   |
| VIN3O1251    | 12"x51" | 6.5 Lbs./Ctn. |
| VIN3O1255    | 12"x55" | 7.5 Lbs./Ctn. |
| VIN3O1259    | 12"x59" | 8 Lbs./Ctn.   |
| VIN3O1263    | 12"x63" | 8 Lbs./Ctn.   |
| VIN3O1267    | 12"x67" | 8.5 Lbs./Ctn. |
| VIN3O1271    | 12"x71" | 9 Lbs./Ctn.   |
| VIN3O1275    | 12"x75" | 9.5 Lbs./Ctn. |
| VIN3O1281    | 12"x81" | 10 Lbs./Ctn.  |



Closed Style



Open Style

- 11 White
- 33 Black
- 99 Blackwatch Green
- 41 Blue
- 59 Brown
- BLU Coastal Blue
- IJ Dark Berry
- 95 Dark Navy
- 56 Dark Spruce
- 55 Green
- 16 Grey
- 52 Pebblestone Clay
- PE Peppercorn
- 38 Red
- CRM Sand Dollar
- 93 Spanish Moss
- SL Terra Brown
- SK Vineyard Red
- 58 Winestone

#### SHERWIN-WILLIAMS®

- EGF Evergreen Fog, SW 9130
- GAF Gale Force, SW 7605
- URB Urbane Bronze, SW 7048

Notes: All shutter dimensions are nominal. Board+Batten shutter cartons include steel mounting screws.

Lengths 51" and smaller have 2 horizontal boards.  
Lengths 55" and longer have 3 horizontal boards.

Sherwin-Williams® is a registered trademark of SWIMC LLC.

# PLY GEM SHUTTERS

## STANDARD 15" & 16" BOARD+BATTEN

### DESCRIPTION & PACKAGING

### COLOR AVAILABILITY

VIN4C15 & VIN4O16

#### Standard Board+Batten 4-Board Shutters

- 15" -16" Wide (Nominal)
- High Density Copolymer
- Baked-on Acrylic Finish
- 1 Pair/Ctn.

#### CLOSED

| Product Code | Length  | Lbs./Ctn.      |
|--------------|---------|----------------|
| VIN4C1531    | 15"x31" | 6 Lbs./Ctn.    |
| VIN4C1535    | 15"x35" | 6.5 Lbs./Ctn.  |
| VIN4C1539    | 15"x39" | 7 Lbs./Ctn.    |
| VIN4C1543    | 15"x43" | 7.5 Lbs./Ctn.  |
| VIN4C1547    | 15"x47" | 8 Lbs./Ctn.    |
| VIN4C1551    | 15"x51" | 8.5 Lbs./Ctn.  |
| VIN4C1555    | 15"x55" | 10 Lbs./Ctn.   |
| VIN4C1559    | 15"x59" | 10 Lbs./Ctn.   |
| VIN4C1563    | 15"x63" | 10.5 Lbs./Ctn. |
| VIN4C1567    | 15"x67" | 11 Lbs./Ctn.   |
| VIN4C1571    | 15"x71" | 11.5 Lbs./Ctn. |
| VIN4C1575    | 15"x75" | 12 Lbs./Ctn.   |
| VIN4C1581    | 15"x81" | 13 Lbs./Ctn.   |

#### OPEN

| Product Code | Length  | Lbs./Ctn.      |
|--------------|---------|----------------|
| VIN4O1631    | 16"x31" | 6 Lbs./Ctn.    |
| VIN4O1635    | 16"x35" | 6.5 Lbs./Ctn.  |
| VIN4O1639    | 16"x39" | 7 Lbs./Ctn.    |
| VIN4O1643    | 16"x43" | 7.5 Lbs./Ctn.  |
| VIN4O1647    | 16"x47" | 8 Lbs./Ctn.    |
| VIN4O1651    | 16"x51" | 8.5 Lbs./Ctn.  |
| VIN4O1655    | 16"x55" | 10 Lbs./Ctn.   |
| VIN4O1659    | 16"x59" | 10.5 Lbs./Ctn. |
| VIN4O1663    | 16"x63" | 11 Lbs./Ctn.   |
| VIN4O1667    | 16"x67" | 11.5 Lbs./Ctn. |
| VIN4O1671    | 16"x71" | 12 Lbs./Ctn.   |
| VIN4O1675    | 16"x75" | 12.5 Lbs./Ctn. |
| VIN4O1681    | 16"x81" | 13 Lbs./Ctn.   |



Closed Style



Open Style

- 11 White
- 33 Black
- 99 Blackwatch Green
- 41 Blue
- 59 Brown
- BLU Coastal Blue
- IJ Dark Berry
- 95 Dark Navy
- 56 Dark Spruce
- 55 Green
- 16 Grey
- 52 Pebblestone Clay
- PE Peppercorn
- 38 Red
- CRM Sand Dollar
- 93 Spanish Moss
- SL Terra Brown
- SK Vineyard Red
- 58 Winestone

#### SHERWIN-WILLIAMS®

- EGF Evergreen Fog, SW 9130
- GAF Gale Force, SW 7605
- URB Urbane Bronze, SW 7048

Notes: All shutter dimensions are nominal. Board+Batten shutter cartons include steel mounting screws.

Lengths 51" and smaller have 2 horizontal boards.  
Lengths 55" and longer have 3 horizontal boards.

The following lengths of VIN4C are molded panels - 47", 55", 59", 63", and 71".

Sherwin-Williams® is a registered trademark of SWIMC LLC.

# PLY GEM SHUTTERS

## ARCHED TOP 14" BOARD+BATTEN

### DESCRIPTION & PACKAGING

### COLOR AVAILABILITY

#### BBARCH

#### Arch Top Board+Batten Shutter

- 14" Wide (Nominal)
- High Density Copolymer
- Baked-on Acrylic Finish
- 1 Pair/Ctn.

| Product Code | Length | Lbs./Ctn.      |
|--------------|--------|----------------|
| BBARCH41     | 41"    | 7 Lbs./Ctn.    |
| BBARCH43     | 43"    | 7.5 Lbs./Ctn.  |
| BBARCH47     | 47"    | 8 Lbs./Ctn.    |
| BBARCH57     | 57"    | 9.5 Lbs./Ctn.  |
| BBARCH61     | 61"    | 10 Lbs./Ctn.   |
| BBARCH65     | 65"    | 10.5 Lbs./Ctn. |
| BBARCH71     | 71"    | 11.5 Lbs./Ctn. |
| BBARCH73     | 73"    | 12 Lbs./Ctn.   |
| BBARCH77     | 77"    | 12.5 Lbs./Ctn. |
| BBARCH85     | 85"    | 13 Lbs./Ctn.   |

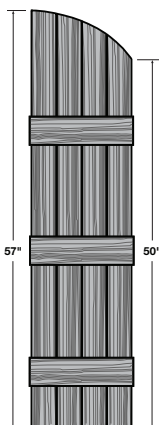

- 11 White
- 33 Black
- 99 Blackwatch Green
- 41 Blue
- 59 Brown
- BLU Coastal Blue
- IJ Dark Berry
- 95 Dark Navy
- 56 Dark Spruce
- 55 Green
- 16 Grey
- 52 Pebblestone Clay
- PE Peppercorn
- 38 Red
- CRM Sand Dollar
- 93 Spanish Moss
- SL Terra Brown
- SK Vineyard Red
- 58 Winestone

#### SHERWIN-WILLIAMS®

- EGF Evergreen Fog, SW 9130
- GAF Gale Force, SW 7605
- URB Urbane Bronze, SW 7048



[Installing Shutters](#)

Notes: All shutter dimensions are nominal. Board+Batten shutter cartons include steel mounting screws.

Sherwin-Williams® is a registered trademark of SWIMC LLC.



## DESCRIPTION & PACKAGING

## COLOR AVAILABILITY

### Custom Open Louvered Panel Shutters

- 9", 12" or 15" Wide (Nominal)
- High Density Copolymer
- Baked-on Acrylic Finish
- 1 Pair/Ctn.

#### Product Code

Example: CLV1530

CLV1530 = CLV + width + length

Custom Louvered Panel = CLV

Width = 15"

Length = 30"



Regular Style

|     |                  |
|-----|------------------|
| 11  | White            |
| 33  | Black            |
| 99  | Blackwatch Green |
| 41  | Blue             |
| 59  | Brown            |
| BLU | Coastal Blue     |
| IJ  | Dark Berry       |
| 95  | Dark Navy        |
| 56  | Dark Spruce      |
| 55  | Green            |
| 16  | Grey             |
| 52  | Pebblestone Clay |
| PE  | Peppercorn       |
| 38  | Red              |
| CRM | Sand Dollar      |
| 93  | Spanish Moss     |
| SL  | Terra Brown      |
| SK  | Vineyard Red     |
| 58  | Winestone        |

### Custom Raised Panel Shutters

- 12" or 15" Wide (Nominal)
- High Density Copolymer
- Baked-on Acrylic Finish
- 1 Pair/Ctn.

#### Product Code

Example: CRP1530

CRP1530 = CRP + width + length

Custom Raised Panel = CRP

Width = 15"

Length = 30"

Lengths available: 18"-96"



Regular Style

#### SHERWIN-WILLIAMS®

|     |                           |
|-----|---------------------------|
| EGF | Evergreen Fog,<br>SW 9130 |
| GAF | Gale Force,<br>SW 7605    |
| URB | Urbane Bronze,<br>SW 7048 |

Notes: All shutter dimensions are nominal. All louvered and raised panel shutter cartons include 3" painted steel mounting screws and shutter plugs.

Sherwin-Williams® is a registered trademark of SWIMC LLC.

# PLY GEM SHUTTERS ACCESSORIES

## DESCRIPTION & PACKAGING

## COLOR AVAILABILITY

### ARCH15RP

#### 15" Raised Panel Arch Top

- 1 Pair/Ctn.
- 3 Lbs./Ctn.

\* For standard shutters only

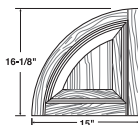

### TRANRP15

#### 15" Raised Panel Transom Top

- 1 Pair/Ctn.
- 3 Lbs./Ctn.

\* For standard shutters only

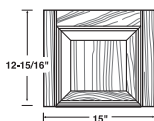

Notes: All shutter dimensions are nominal. All louvered and raised panel shutter cartons include 3" painted steel mounting screws and shutter plugs.

Not for use with custom shutters

### ARCH15LV

#### 15" Open Louvered Arch Top

- 1 Pair/Ctn.
- 3 Lbs./Ctn.

\* For standard shutters only

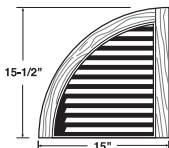

- 11 White
- 33 Black
- 99 Blackwatch Green
- 41 Blue
- 59 Brown
- BLU Coastal Blue
- IJ Dark Berry
- 95 Dark Navy
- 56 Dark Spruce
- 55 Green
- 16 Grey
- 52 Pebblestone Clay
- PE Peppercorn
- 38 Red
- CRM Sand Dollar
- 93 Spanish Moss
- SL Terra Brown
- SK Vineyard Red
- 58 Winestone

#### **SHERWIN-WILLIAMS®**

- EGF Evergreen Fog,  
SW 9130
- GAF Gale Force,  
SW 7605
- URB Urbane Bronze,  
SW 7048

## DESCRIPTION & PACKAGING

## COLOR AVAILABILITY

### SHUTTRPLUG

#### Fastener

- 1/4" x 2-5/8"
- 12 Pcs./Pkg.

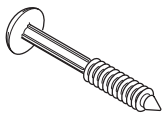

### VINITT

#### Painted Steel Replacement Screws

- 3/16" x 3"
- 4 Pcs./Pkg.



- 11 White
- 33 Black
- 99 Blackwatch Green
- 41 Blue
- 59 Brown
- BLU Coastal Blue
- IJ Dark Berry
- 95 Dark Navy
- 56 Dark Spruce
- 55 Green
- 16 Grey
- 52 Pebblestone Clay
- PE Peppercorn
- 38 Red
- CRM Sand Dollar
- 93 Spanish Moss
- SL Terra Brown
- SK Vineyard Red
- 58 Winestone

#### SHERWIN-WILLIAMS®

- EGF Evergreen Fog,  
SW 9130
- GAF Gale Force,  
SW 7605
- URB Urbane Bronze,  
SW 7048

### SHTCLP12

Mill Finish

#### Shutter Clips and Anchors

- 12 Pc. = 1 Each
- 50 Each = 1 Ctn.

\*For standard shutters only.



### SHOOK

33 Black

#### Hooks and Hinges

Includes:

- (4) Hinges,
- (2) S-Hooks  
(right and left)
- (10) Screws

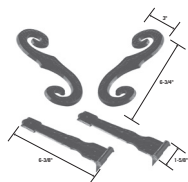

Sherwin-Williams® is a registered trademark of SWIMC LLC.

# PLY GEM SHUTTERS ACCESSORIES

DESCRIPTION & PACKAGING

COLOR AVAILABILITY

## PEDIMENTST

11 White (paintable)

### Pediment Set

- Pediment Height: 12-3/4"
- Overall Height: 18-1/2"
- 1 Pc./Ctn.
- 8 Lbs./Ctn.

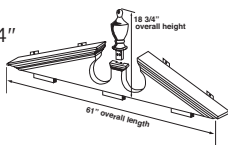

## MANTEL

### Door Surround Mantel

- Length: 58"
- 1 Pc./Ctn.
- 7.41 Lbs./Ctn.

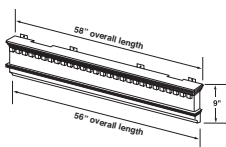

## MANTELOVLY

### Door Mantel Overlay

- Length: 10-1/2"
- 6 Pcs./Ctn.
- 6.24 Lbs./Ctn.

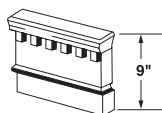

## TOPCAP

### Pilaster Cap

- 1 Pc./Ctn.
- .23 Lb./Ctn.

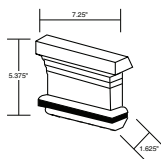

## BASECAP

### Pilaster Base

- 1 Pc./Ctn.
- .56 Lb./Ctn.

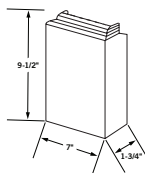

[Installing door  
surrounds](#)

## DESCRIPTION & PACKAGING

## COLOR AVAILABILITY

### PILASTER96

11 White (paintable)

#### 96" Pilaster Set

- 2 Pilasters
- 6 Mounting Clips
- 2 Pilaster Caps
- 2 Pilaster Bases
- Width: 7-1/2"
- Height: 96"
- 1 Pair/Ctn.
- 15.49 Lbs./Ctn.



### PILASTER144

#### 144" Pilaster Set

- 2 Pilasters
- 6 Mounting Clips
- 2 Pilaster Caps
- 2 Pilaster Bases
- Width: 7-1/2"
- Height: 144"
- 1 Pair/Ctn.
- 19.71 Lbs./Ctn.

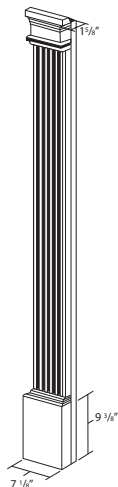

# PLY GEM SHUTTERS ACCESSORIES

DESCRIPTION & PACKAGING

COLOR AVAILABILITY

## MANTEL120

11 White (paintable)

### 120" Mantel System

Mantel:

- Face Height: 7-3/8"
- Length: 120"

Plain Cover Strip:

- Height: 1"
- Length: 120"
- Thickness: .139

Mantel System Includes:

- 1 - Mantel (120")
- 1 - Plain Cover Strip (120")
- 16 - (8) Anchors and (8) Screw/Washers
- 1 Mantel System/Ctn.
- 15.25 Lbs./Ctn.

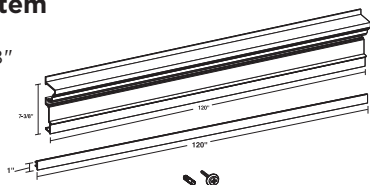

## DENTILSTP

### 60" Dentil Strip

- Height: 1"
- Length: 60"
- 2 Pcs./Ctn.
- 2.4 Lbs./Ctn.

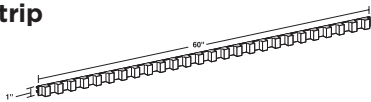

## KEYSTN

### Keystone for 120" Mantel System

- Height: 7-1/2"
- Top Width: 7"
- Bottom Length: 4-3/4"
- 1 Pc./Ctn.
- 1.26 Lb./Ctn.

(includes mounting hardware)

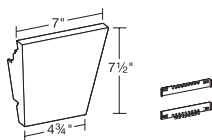

## SDGENDCAP

### Siding Endcaps for 120" Mantel System

- Height: 7-3/8"
- Width: 3-1/4"
- 2 Pcs./Ctn.
- 2.98 Lbs./Ctn.

(includes adhesive)

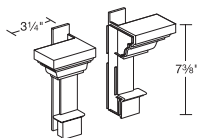

## BRKENDCAP

### Brick Endcaps for 120" Mantel System

- Height: 7-3/8"
- Width: 3-1/4"
- 2 Pcs./Ctn.
- 3.06 Lbs./Ctn.

(includes adhesive)

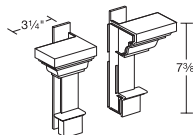

## DESCRIPTION & PACKAGING

## COLOR AVAILABILITY

### 36" 40" 44" Window Mantel

11 White (paintable)

- Height: 7-1/4"
- 1 Pc./Ctn.

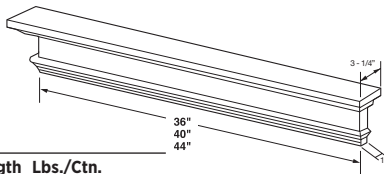

| Product Code | Length | Lbs./Ctn.      |
|--------------|--------|----------------|
| PLWINMTL36   | 36"    | 6 Lbs./Ctn.    |
| PLWINMTL40   | 40"    | 6.54 Lbs./Ctn. |
| PLWINMTL44   | 44"    | 7 Lbs./Ctn.    |

### 36" 40" 44" Window Mantel with Dentil Trim

- Height: 7-1/4"
- 1 Pc./Ctn.

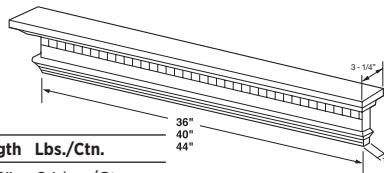

| Product Code | Length | Lbs./Ctn.      |
|--------------|--------|----------------|
| DTWINMTL36   | 36"    | 6 Lbs./Ctn.    |
| DTWINMTL40   | 40"    | 6.54 Lbs./Ctn. |
| DTWINMTL44   | 44"    | 7 Lbs./Ctn.    |

## KEYSTONE

### Keystone

- Height: 8-3/4"
- Length: 7-3/4"
- 1 Lb./Ctn.
- 1 Pc./Ctn.

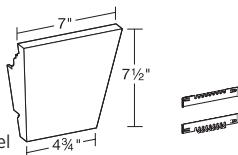

For use with window mantel

## ENDCAP

### Endcap for Window Mantel

- 1 Pc./Ctn.
- .82 Lb./Ctn.

(includes adhesive)

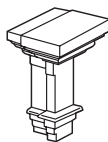

[Installing  
10 foot mantel](#)

[Installing door  
surrounds](#)



# PLY GEM SHUTTERS | ACCENTS COLOR MATRIX

DESCRIPTION & PACKAGING

COLOR AVAILABILITY

| Manufacturer | Code | Color                                    |
|--------------|------|--|
| TRUEWALL     | 53   | Almond                                   |
| TRUEWALL     | 254  | Amber                                    |
| TRUEWALL     | 145  | Bayou                                    |
| TRUEWALL     | EX   | Beige                                    |
| TRUEWALL     | BK   | Blue Bayou                               |
| TRUEWALL     | 100  | Briarwood/Maple*/Shaded Cedar*           |
| TRUEWALL     | 803  | Brownstone                               |
| TRUEWALL     | 812  | Brunswick                                |
| TRUEWALL     | S7   | Cherry*                                  |
| TRUEWALL     | BQ   | Chestnut*/Hearthstone Brown*             |
| TRUEWALL     | 802  | Cinnabar                                 |
| TRUEWALL     | PC   | Clay/Northern Oak*                       |
| TRUEWALL     | 30   | Cream                                    |
| TRUEWALL     | 246  | Cypress                                  |
| TRUEWALL     | 813  | Dublin                                   |
| TRUEWALL     | ED   | Flint/Shaded Gray*                       |
| TRUEWALL     | 02   | Gray                                     |
| TRUEWALL     | 290  | Hampton Red                              |
| TRUEWALL     | 260  | Hazelnut                                 |
| TRUEWALL     | 814  | Iron                                     |
| TRUEWALL     | BI   | Mist                                     |
| TRUEWALL     | N5   | Musket Brown                             |
| TRUEWALL     | FQ   | Oak*                                     |
| TRUEWALL     | 511  | Olive                                    |
| TRUEWALL     | IC   | Palm                                     |
| TRUEWALL     | PP   | Pearl                                    |
| TRUEWALL     | 090  | Pewter/Coastal Blue*/Ironwood*/Sycamore* |
| TRUEWALL     | ID   | Redwood*                                 |
| TRUEWALL     | 170  | Sagebrook/Mesquite*                      |
| TRUEWALL     | 144  | Shadow                                   |
| TRUEWALL     | A7   | Tan                                      |
| TRUEWALL     | IF   | Teak                                     |
| TRUEWALL     | 510  | Thistle                                  |
| TRUEWALL     | 390  | Wedgewood                                |
| TRUEWALL     | AW   | White                                    |

\* Recommended solid match for variegated color.



## DESCRIPTION & PACKAGING

## COLOR AVAILABILITY

420-04

### **Solid Panel Deep Woodgrain Finish**

- Length: 12' 0"
- 16" exposure
- 61 Lbs./Ctn.
- 12 Panels/Ctn.



White  
Clay  
Cream  
Gray  
Pearl  
Tan

422-04

### **Center Vent Panel Basketweave Finish**

- Length: 12' 0"
- 16" exposure
- 61 Lbs./Ctn.
- 12 Panels/Ctn.



# PARKSIDE® SKIRTING ACCESSORIES

## DESCRIPTION & PACKAGING

## COLOR AVAILABILITY

471

### Top Back Rail

- Length: 11' 6"
- 61 Lbs./Ctn.
- 28 Pc./Ctn. / 322 Ln. Ft.



White  
Clay  
Cream  
Gray  
Pearl  
Tan

472

### Hinge Style Top Front Rail

- Length: 11' 7-1/4"
- 61 Lbs./Ctn.
- 28 Pc./Ctn. / 328 Ln. Ft.



473

### Bottom Rail

- Length: 11' 6"
- 58 Lbs./Ctn.
- 28 Pc./Ctn. / 322 Ln. Ft.



513

### Skirting Hardware

- Length: 250 1" Attachment Screws and 125 Ground Spikes per carton



N/A

456

### Hinge Style Trim Pack

- 108 Lbs./Ctn.
- 14 pieces each: Top Back, Front and Bottom Rails
- 250 - Screws
- 125 - 7" Spikes

White  
Clay  
Cream  
Gray  
Pearl  
Tan

457

### Wind Resistant Trim Pack

- 107.40 Lbs./Ctn.
- 14 pieces each: Top Back, Front and Bottom Rails
- 250 - Screws
- 125 - 7" Spikes

# APPLICATION TOOLS

DESCRIPTION & PACKAGING

COLOR AVAILABILITY

552

**Snap Lock Punch**

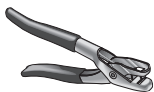

N/A

553

**Unlocking Tool**

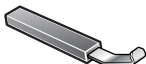

554

**Nail Hole Punch**



[How to cut  
vinyl siding](#)

[How to use vinyl  
siding specialty  
tools](#)



1WAP10 00

Mill Finish

## Beaded Starter Strip

- Width: 2-1/8"
- Length: 10' 0"
- 27 Lbs./Ctn.
- 40 Pcs./Ctn.
- 250 Ft.

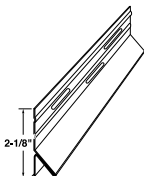

VSS10NS 00

## Wide Aluminum Starter Strip

- Width: 2-1/2"
- Length: 10' 0"
- 32.7 Lbs./Ctn.
- 50 Pcs./Ctn.
- 500 Ft.

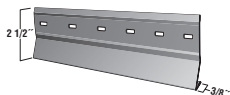

CPSSHD

## Cedar Galvanized Steel Starter Strip

- Length: 10' 0"
- Galvanized Steel
- 49 Lbs./Ctn.
- 25 Pcs./Ctn.
- 250 Lin./Ft.

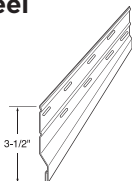

CDSS

## Cedar Aluminum Starter Strip

- Length: 10' 0"
- 32 Lbs./Ctn.
- 50 Pcs./Ctn.
- 500 Ft.

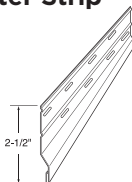

[Starter strip](#)

NOTES:

---

NOTES:

---





## Looking for the perfect finishing touch?

A complete line of color accessories adds the perfect finishing touch to any home. Create a unique statement by choosing a contrasting or matching accessory to complete the look of a virtually maintenance-free home.

## Designed for life with a warranty for a lifetime.

The durability and natural beauty of TrueWall vinyl siding products are backed by a Limited Lifetime Transferable Warranty\*.

Contact your distributor for actual product samples.

\*Warranty: TrueWall products have TrueWall's Limited Lifetime Transferable Warranty that is backed by Variform, Inc. Consult the actual product warranty for complete coverage details.

2600 Grand Blvd., Suite 900 • Kansas City, MO 64108



ASTM  
D 3679



\*Consult the VSI Web site at [vinylsiding.org](http://vinylsiding.org) for a current list of qualified products and colors.

True to you. True to your craft. By Ply Gem: © 2023 Variform, Inc., part of Cornerstone Building Brands, Inc.  
ALL RIGHTS RESERVED. Printed in the U.S.A. 450109501101/Rev H/MS/CG/0823

< PREVIOUS PAGE | SPEC GUIDE CONTENTS | SPEC GUIDE COVER >